



Supplemental Instructions

Rib Doors: Commercial

 CAUTION	<p>Higher wind pressures and larger doors require additional reinforcement.</p> <p>Premature failure of door system may result from improper application.</p> <p>See chart in lower left corner of drawing sheet one for the approved wind pressures and door sizes.</p>
--	---

 WARNING	<p>These supplemental instructions do not contain basic door installation steps and related safety information.</p> <p>Failure to follow basic installation steps and related safety information may result in injury or death.</p> <p>Door installers must follow a primary instruction manual for basic door installation steps and related safety information.</p>
--	--

The correct selection of door and framing materials in adherence with local building code directives is the responsibility of the building owner/designer. Use of a reinforced garage door does not constitute automatic compliance with any building code. Local building code officials determine compliance criteria.

A locking system must be installed if the door is not electrically operated.

See drawing for stop molding requirements, when door is not more than 1" wider than opening. When using stop molding, secure molding with minimum 8d nails or 2-1/2" long screws.

Professional Engineer's seal provided only for verification of wind load construction details. Printed copies of this document are not considered signed and sealed and the signature must be verified on any electronic copies.

John E. Scates, P.E.
 2560 King Arthur, Ste 124-54
 Lewisville, Texas 75056
 TXPE 56308, F-2203
 Florida P.E. # 51737

For Use With Drawing Number Z8i-18-61517

Strut Placement

Section Number	Door Height								
	6'-0" to 8'-0"	8'-3" to 10'-0"	10'-3" to 12'-0"	12'-3" to 14'-0"	14'-3" to 16'-0"	16'-3" to 18'-0"	18'-3" to 20'-0"	20'-3" to 22'-0"	22'-3" to 24'-0"
12	N/A	N/A	N/A	N/A	N/A	N/A	N/A	N/A	1 at Detail A 1 at Detail B
11	N/A	N/A	N/A	N/A	N/A	N/A	N/A	1 at Detail A 1 at Detail B	1 at Detail C 1 at Detail D 1 at Detail B
10	N/A	N/A	N/A	N/A	N/A	N/A	1 at Detail A 1 at Detail B	1 at Detail C 1 at Detail D 1 at Detail B	1 at Detail C 1 at Detail B
9	N/A	N/A	N/A	N/A	N/A	1 at Detail A 1 at Detail B	1 at Detail C 1 at Detail D 1 at Detail B	1 at Detail C 1 at Detail B	1 at Detail C 1 at Detail B
8	N/A	N/A	N/A	N/A	1 at Detail A 1 at Detail B	1 at Detail C 1 at Detail D 1 at Detail B	1 at Detail C 1 at Detail B	1 at Detail C 1 at Detail D 1 at Detail B	1 at Detail C 1 at Detail B
7	N/A	N/A	N/A	1 at Detail A 1 at Detail B	1 at Detail C 1 at Detail D 1 at Detail B	1 at Detail C 1 at Detail B	1 at Detail C 1 at Detail D 1 at Detail B	1 at Detail C 1 at Detail B	1 at Detail C 1 at Detail D 1 at Detail B
6	N/A	N/A	1 at Detail A 1 at Detail B	1 at Detail C 1 at Detail D 1 at Detail B	1 at Detail C 1 at Detail B	1 at Detail C 1 at Detail D 1 at Detail B	1 at Detail C 1 at Detail B	1 at Detail C 1 at Detail D 1 at Detail B	1 at Detail C 1 at Detail B
5	N/A	1 at Detail A 1 at Detail B	1 at Detail C 1 at Detail D 1 at Detail B	1 at Detail C 1 at Detail B	1 at Detail C 1 at Detail D 1 at Detail B	1 at Detail C 1 at Detail B	1 at Detail C 1 at Detail D 1 at Detail B	1 at Detail C 1 at Detail B	1 at Detail C 1 at Detail D 1 at Detail B
4	1 at Detail A 1 at Detail B	1 at Detail C 1 at Detail D 1 at Detail B	1 at Detail C 1 at Detail D 1 at Detail B	1 at Detail C 1 at Detail D 1 at Detail B	1 at Detail C 1 at Detail B	1 at Detail C 1 at Detail D 1 at Detail B	1 at Detail C 1 at Detail B	1 at Detail C 1 at Detail B	1 at Detail C 1 at Detail B
3	1 at Detail C 1 at Detail D 1 at Detail B	1 at Detail C 1 at Detail D 1 at Detail B	1 at Detail C 1 at Detail D 1 at Detail B	1 at Detail C 1 at Detail D 1 at Detail B	1 at Detail C 1 at Detail B	1 at Detail C 1 at Detail D 1 at Detail B	1 at Detail C 1 at Detail D 1 at Detail B	1 at Detail C 1 at Detail D 1 at Detail B	1 at Detail C 1 at Detail D 1 at Detail B
2	1 at Detail C 1 at Detail B	1 at Detail C 1 at Detail B	1 at Detail C 1 at Detail B	1 at Detail C 1 at Detail B	1 at Detail C 1 at Detail B	1 at Detail C 1 at Detail B	1 at Detail C 1 at Detail B	1 at Detail C 1 at Detail B	1 at Detail C 1 at Detail B
1	1 at Detail C 1 at Detail E 1 at Detail F	1 at Detail C 1 at Detail E 1 at Detail F	1 at Detail C 1 at Detail E 1 at Detail F	1 at Detail C 1 at Detail E 1 at Detail F	1 at Detail C 1 at Detail E 1 at Detail F	1 at Detail C 1 at Detail E 1 at Detail F	1 at Detail C 1 at Detail E 1 at Detail F	1 at Detail C 1 at Detail E 1 at Detail F	1 at Detail C 1 at Detail E 1 at Detail F

Push Nut Detail (use on all rollers)

- use 3/8" I. D. on bottom fixture roller stem
- use 7/16" I. D. on end hinge and top fixture roller stems

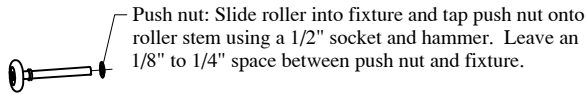

Track Bracket Spacing

Track bracket spacing shown for doors up to four sections high. Additional door sections may be added for maximum door height depicted on line drawing. Track brackets must be added (per track) for each section and spaced at a distance not greater than the corresponding section height (see line drawing for required quantities).

	Do Not Exceed
H	14"
G	14"
F	15"
E	9"
D	14-1/2"
C	9-1/2"
B	6-1/2"
A	3-1/2"

+/-3" tolerance

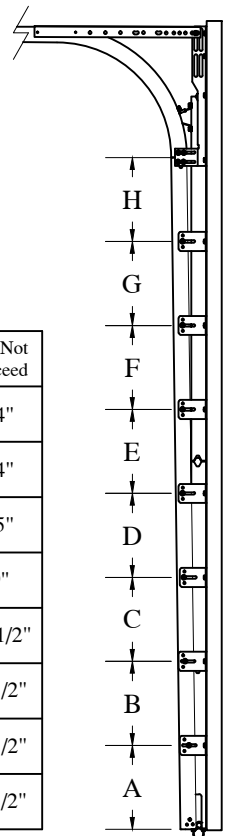

**For Use With Drawing Number
Z8i-18-61517**

Strut Placement Detail

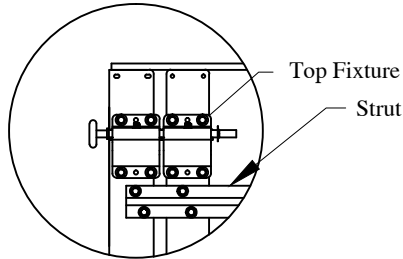

Strut above top fixture

Detail A

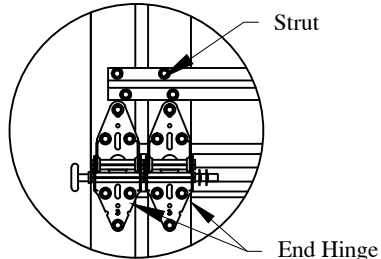

Strut above the hinge

Detail B

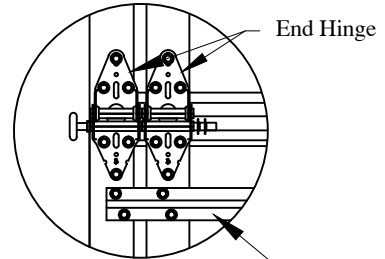

Strut below the hinge

Detail C

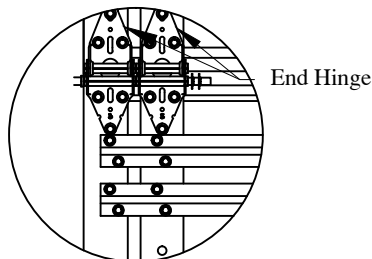

Second Strut below hinge

Detail D

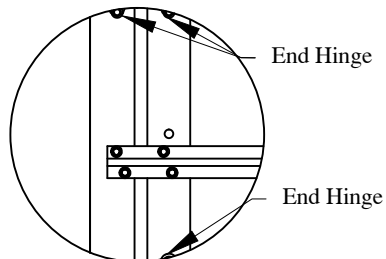

Strut in center of section

Detail E

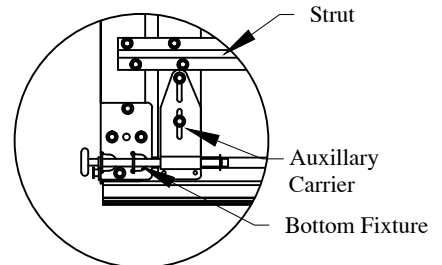

Strut above auxillary carrier

Detail F

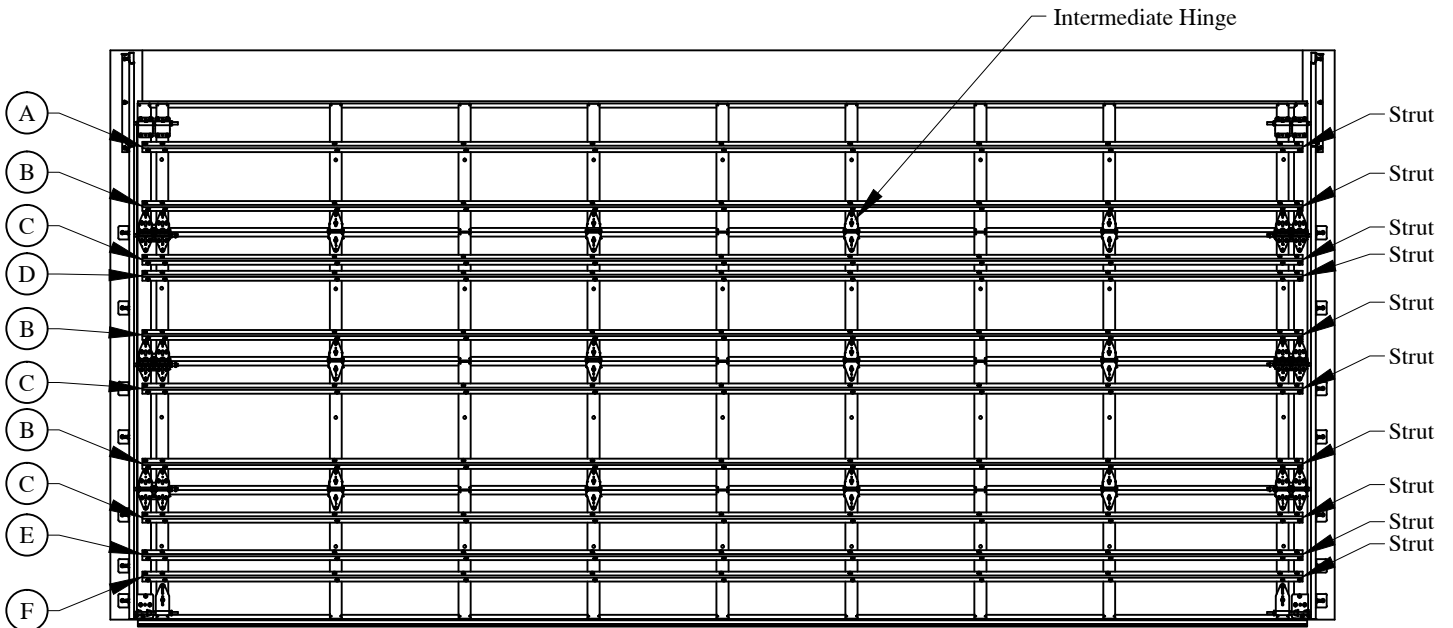

10 Struts

Glazing Options: No Glazing Options Available

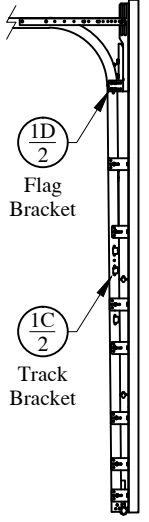
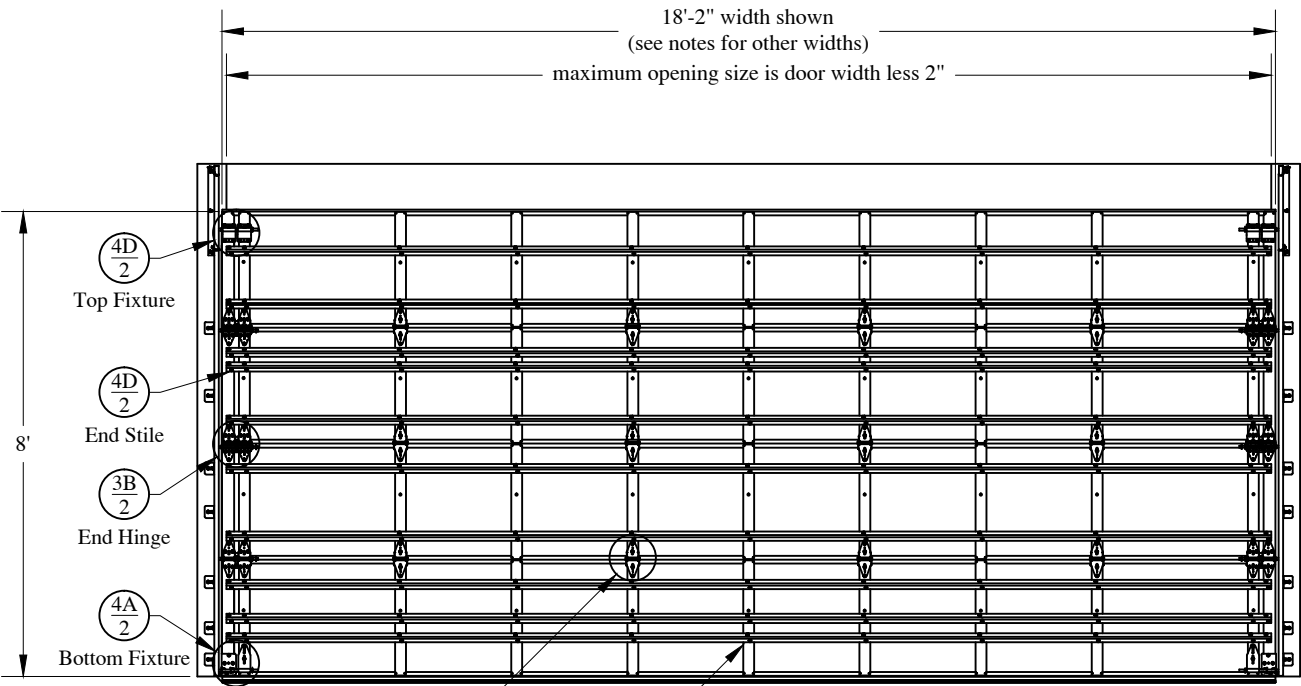

Door Height	Section Quantity	Strut Quantity	Trk Brkt Per Side
6'-0" to 8'-0"	4	10	7
8'-3" to 10'-0"	5	13	10
10'-3" to 12'-0"	6	15	12
12'-3" to 14'-0"	7	18	14
14'-3" to 16'-0"	8	20	15
16'-3" to 18'-0"	9	23	16
18'-3" to 20'-0"	10	25	18
20'-3" to 22'-0"	11	27	20
22'-3" to 24'-0"	12	29	23

Track bracket quantities shown are for use with grade 2 or better Southern Yellow Pine. Refer to Jamb Attachment Detail supplemental instructions for usage of alternate jamb materials.

Supporting structural elements shall be designed by a registered professional engineer for wind loads shown on this drawing. If door is not electrically operated, a lock must be installed.

Complies with IBC/IRC 2018. Tested per ANSI/DASMA 108 and 115
 Maximum door height: 24'-00"
 Door has been tested for windborne debris.

Width	Design Pressure (PSF)	Stile Qty.
20'-02"	+30.7 / -30.7	9
19'-02"	+34.0 / -34.0	9
18'-02"	+37.3 / -37.8	7
16'-02"	+37.3 / -41.9	7
15'-02"	+37.3 / -41.9	7

John E. Scates, P.E.
 2560 King Arthur, Ste 124-54
 Lewisville, Texas 75056
 TXPE 56308, F-2203
 Florida P.E. # 51737

Professional Engineer's seal provided only for verification of windload construction details

	SCALE	nts
	DATE	03-10-2022
Model Series: Rib Doors, Commercial		
C.H.I. Drawing: Z8i-18-61517		
page 4 of 5		

Details on some views may have been omitted for clarity.

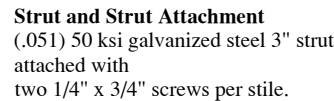
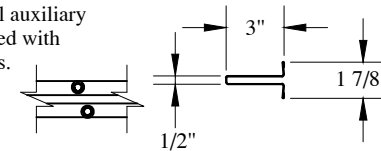
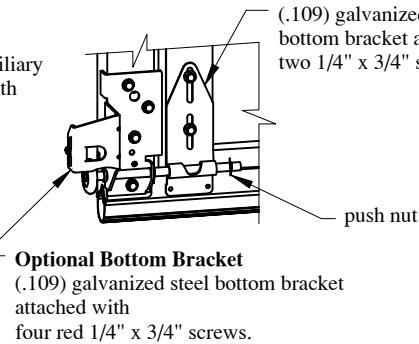
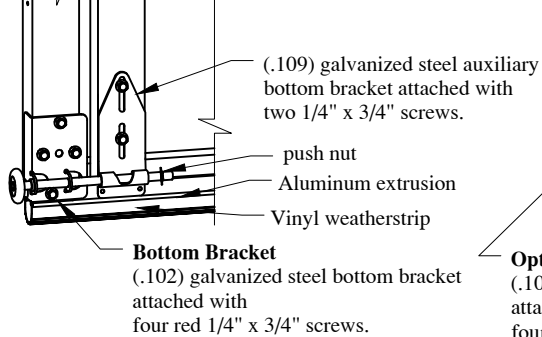
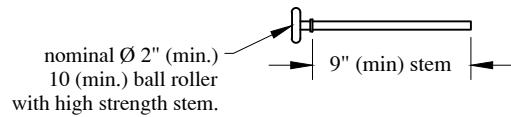
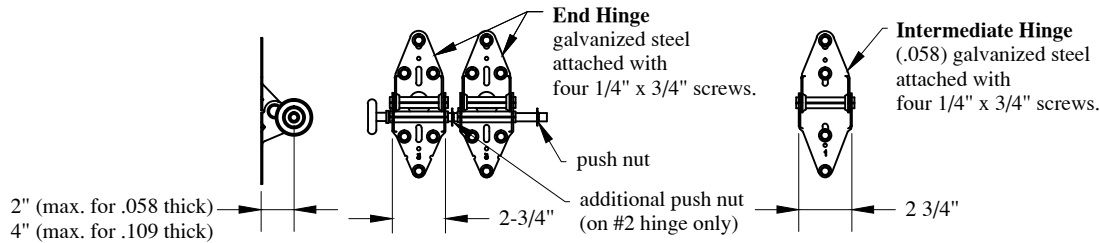
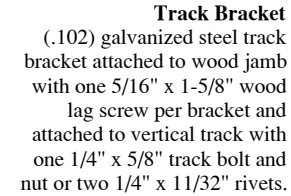
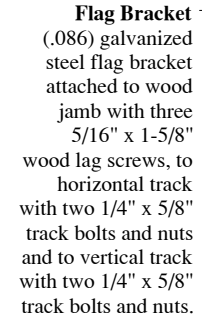
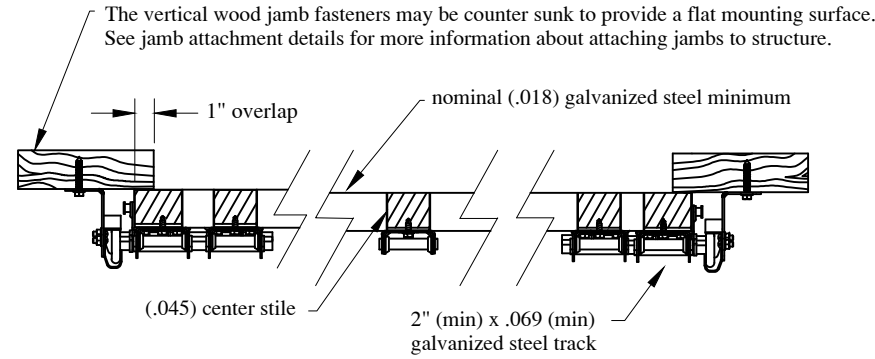
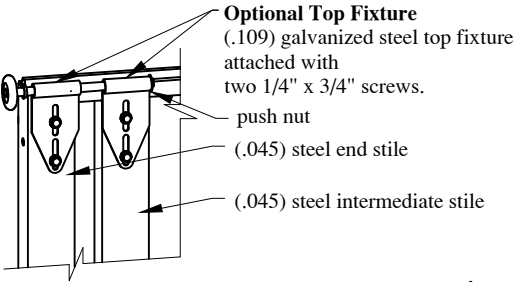
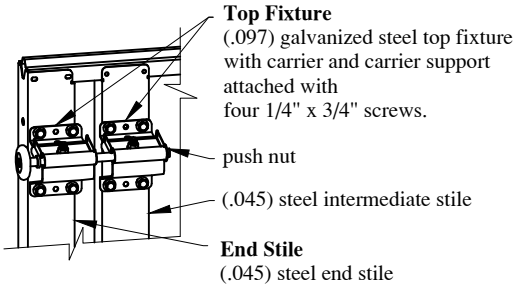

John E. Scates, P.E.
 2560 King Arthur, Ste 124-54
 Lewisville, Texas 75056
 TXPE 56308, F-2203
 Florida P.E. # 51737

Professional Engineer's seal provided only for verification of windload construction details

C.H.I.	SCALE	nts
	DATE	03-10-2022
Model Series: Rib Doors, Commercial		
C.H.I. Drawing: Z8i-18-61517		
page 5 of 5		