



Supplemental Instructions

Rib Doors: Commercial

 CAUTION	<p>Higher wind pressures and larger doors require additional reinforcement.</p> <p>Premature failure of door system may result from improper application.</p> <p>See chart in lower left corner of drawing sheet one for the approved wind pressures and door sizes.</p>
--	---

 WARNING	<p>These supplemental instructions do not contain basic door installation steps and related safety information.</p> <p>Failure to follow basic installation steps and related safety information may result in injury or death.</p> <p>Door installers must follow a primary instruction manual for basic door installation steps and related safety information.</p>
--	--

The correct selection of door and framing materials in adherence with local building code directives is the responsibility of the building owner/designer. Use of a reinforced garage door does not constitute automatic compliance with any building code. Local building code officials determine compliance criteria.

A locking system must be installed if the door is not electrically operated.

See drawing for stop molding requirements, when door is not more than 1" wider than opening. When using stop molding, secure molding with minimum 8d nails or 2-1/2" long screws.

Professional Engineer's seal provided only for verification of wind load construction details. Printed copies of this document are not considered signed and sealed and the signature must be verified on any electronic copies.

John E. Scates, P.E.
 2560 King Arthur, Ste 124-54
 Lewisville, Texas 75056
 TXPE 56308, F-2203
 Florida P.E. # 51737

For Use With Drawing Number Z8i-10-61517

Strut Placement

Section Number	Door Height								
	6'-0" to 8'-0"	8'-3" to 10'-0"	10'-3" to 12'-0"	12'-3" to 14'-0"	14'-3" to 16'-0"	16'-3" to 18'-0"	18'-3" to 20'-0"	20'-3" to 22'-0"	22'-3" to 24'-0"
12	N/A	N/A	N/A	N/A	N/A	N/A	N/A	N/A	1 at Detail A
11	N/A	N/A	N/A	N/A	N/A	N/A	N/A	1 at Detail A	1 at Detail B 1 at Detail C
10	N/A	N/A	N/A	N/A	N/A	N/A	1 at Detail A	1 at Detail B 1 at Detail C	1 at Detail B 1 at Detail C
9	N/A	N/A	N/A	N/A	N/A	1 at Detail A	1 at Detail B 1 at Detail C	1 at Detail B 1 at Detail C	1 at Detail B 1 at Detail C
8	N/A	N/A	N/A	N/A	1 at Detail A	1 at Detail B 1 at Detail C	1 at Detail B 1 at Detail C	1 at Detail B 1 at Detail C	1 at Detail B 1 at Detail C
7	N/A	N/A	N/A	1 at Detail A	1 at Detail B 1 at Detail C	1 at Detail B 1 at Detail C	1 at Detail B 1 at Detail C	1 at Detail B 1 at Detail C	1 at Detail B 1 at Detail C
6	N/A	N/A	1 at Detail A	1 at Detail B 1 at Detail C	1 at Detail B 1 at Detail C	1 at Detail B 1 at Detail C	1 at Detail B 1 at Detail C	1 at Detail B 1 at Detail C	1 at Detail B 1 at Detail C
5	N/A	1 at Detail A	1 at Detail B 1 at Detail C	1 at Detail B 1 at Detail C	1 at Detail B 1 at Detail C	1 at Detail B 1 at Detail C	1 at Detail B 1 at Detail C	1 at Detail B 1 at Detail C	1 at Detail B 1 at Detail C
4	1 at Detail A	1 at Detail B 1 at Detail C	1 at Detail B 1 at Detail C	1 at Detail B 1 at Detail C	1 at Detail B 1 at Detail C	1 at Detail B 1 at Detail C	1 at Detail B 1 at Detail C	1 at Detail B 1 at Detail C	1 at Detail B 1 at Detail C
3	1 at Detail B 1 at Detail C	1 at Detail B 1 at Detail C	1 at Detail B 1 at Detail C	1 at Detail B 1 at Detail C	1 at Detail B 1 at Detail C	1 at Detail B 1 at Detail C	1 at Detail B 1 at Detail C	1 at Detail B 1 at Detail C	1 at Detail B 1 at Detail C
2	1 at Detail B	1 at Detail B	1 at Detail B	1 at Detail B	1 at Detail B	1 at Detail B	1 at Detail B	1 at Detail B	1 at Detail B
1	1 at Detail A	1 at Detail A	1 at Detail A	1 at Detail A	1 at Detail A	1 at Detail A	1 at Detail A	1 at Detail A	1 at Detail A

Push Nut Detail (use on all rollers)

- use 3/8" I. D. on bottom fixture roller stem
- use 7/16" I. D. on end hinge and top fixture roller stems

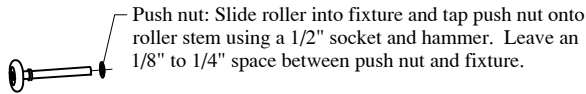

Track Bracket Spacing

Track bracket spacing shown for doors up to four sections high. Additional door sections may be added for maximum door height depicted on line drawing. Track brackets must be added (per track) for each section and spaced at a distance not greater than the corresponding section height (see line drawing for required quantities).

	Do Not Exceed
E	28"
D	24"
C	24"
B	6-1/2"
A	3-1/2"

+/-3" tolerance

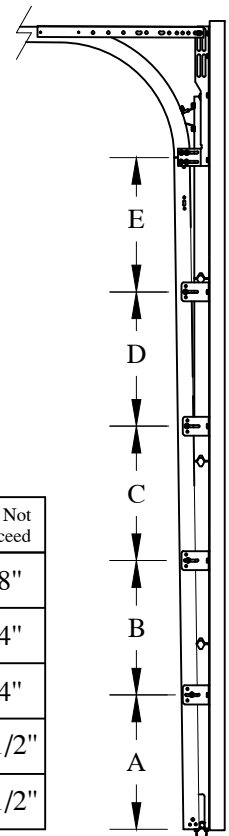

For Use With Drawing Number
Z8i-10-61517

Strut Placement Detail

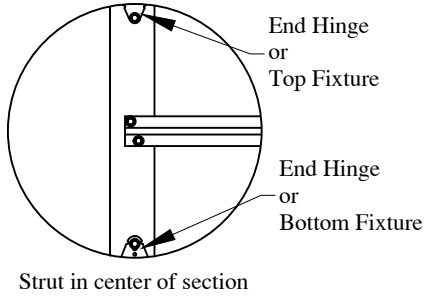

Detail A

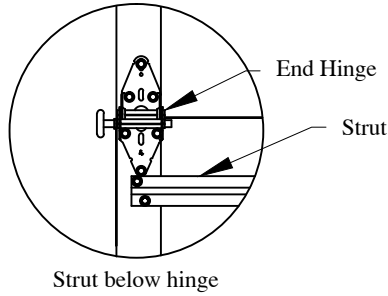

Detail B

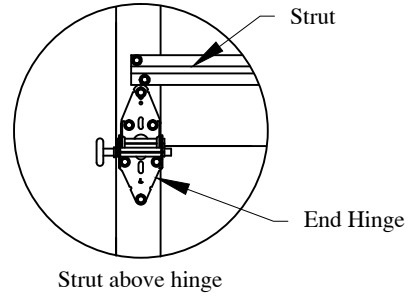

Detail C

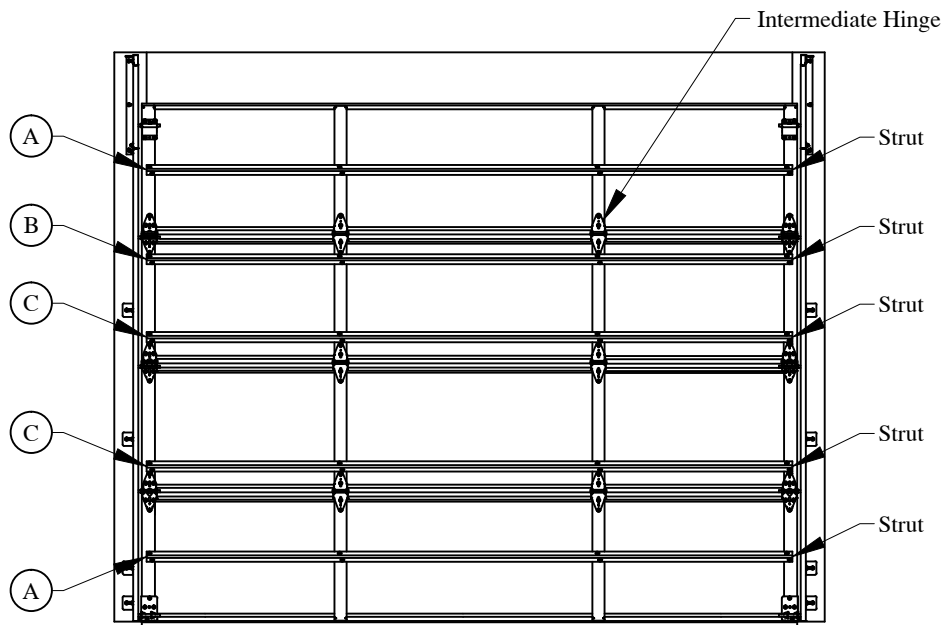

5 Struts

Glazing Options: No Glazing Options Available

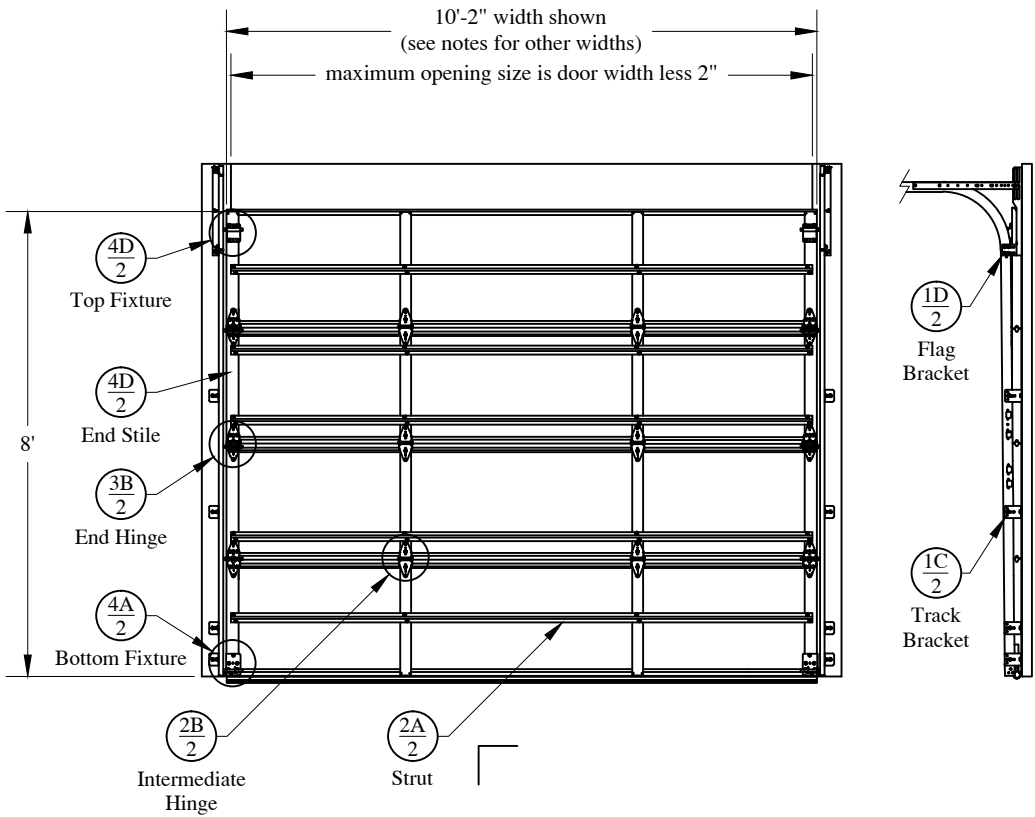

Door Height	Section Quantity	Strut Quantity	Trk Brkt Per Side
6'-0" to 8'-0"	4	5	4
8'-3" to 10'-0"	5	7	5
10'-3" to 12'-0"	6	9	6
12'-3" to 14'-0"	7	11	7
14'-3" to 16'-0"	8	13	9
16'-3" to 18'-0"	9	15	10
18'-3" to 20'-0"	10	17	11
20'-3" to 22'-0"	11	19	13
22'-3" to 24'-0"	12	21	14

Track bracket quantities shown are for use with grade 2 or better Southern Yellow Pine. Refer to Jamb Attachment Detail supplemental instructions for usage of alternate jamb materials.

Supporting structural elements shall be designed by a registered professional engineer for wind loads shown on this drawing. If door is not electrically operated, a lock must be installed.

Complies with IBC/IRC 2018. Tested per ANSI/DASMA 108 and 115

Maximum door height: 24'-00"

Door has been tested for windborne debris.

Width	Design Pressure (PSF)	Stile Qty.
10'-08"	+30.8 / -38.1	2
10'-02"	+33.9 / -41.9	2
9'-06"	+36.3 / -44.8	2
9'-05"	+35.5 / -39.9	1
9'-02"	+37.5 / -42.1	1
8'-02"	+47.2 / -53.1	1
6'-00"	+50.7 / -57.5	1

Professional Engineer's seal provided only for verification of windload construction details

John E. Scates, P.E.
 2560 King Arthur, Ste 124-54
 Lewisville, Texas 75056
 TXPE 56308, F-2203
 Florida P.E. # 51737

	SCALE	nts
	DATE	03-10-2022
Model Series: Rib Doors, Commercial		
C.H.I. Drawing: Z8i-10-61517		
page 4 of 5		

Details on some views may have been omitted for clarity.

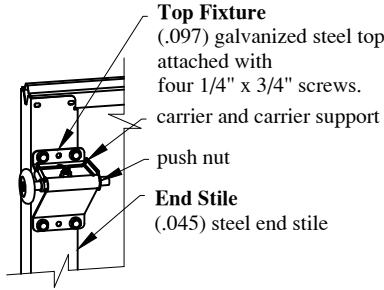

Top Fixture
 (.097) galvanized steel top fixture
 attached with
 four 1/4" x 3/4" screws.
 carrier and carrier support
 push nut
End Stile
 (.045) steel end stile

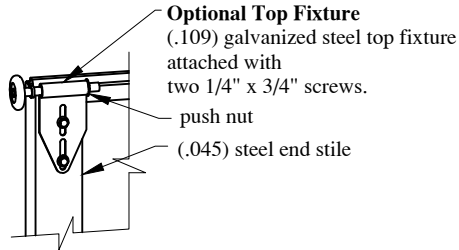

Optional Top Fixture
 (.109) galvanized steel top fixture
 attached with
 two 1/4" x 3/4" screws.
 push nut
 (.045) steel end stile

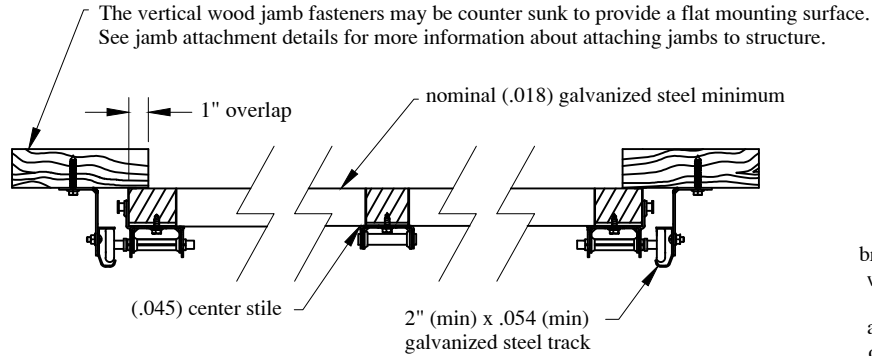

The vertical wood jamb fasteners may be counter sunk to provide a flat mounting surface.
 See jamb attachment details for more information about attaching jambs to structure.

1" overlap
 nominal (.018) galvanized steel minimum
 (.045) center stile
 2" (min) x .054 (min) galvanized steel track

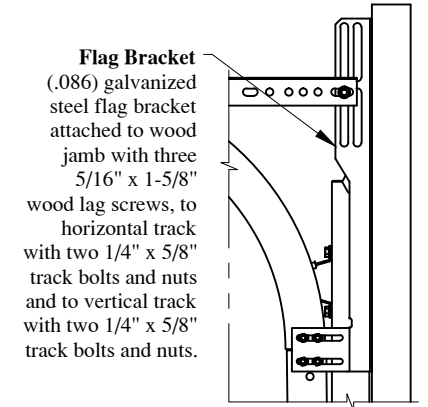

Flag Bracket
 (.086) galvanized steel flag bracket
 attached to wood jamb with three 5/16" x 1-5/8" wood lag screws, to horizontal track with two 1/4" x 5/8" track bolts and nuts and to vertical track with two 1/4" x 5/8" track bolts and nuts.

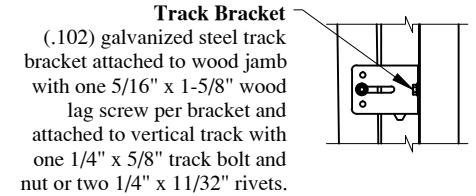

Track Bracket
 (.102) galvanized steel track bracket attached to wood jamb with one 5/16" x 1-5/8" wood lag screw per bracket and attached to vertical track with one 1/4" x 5/8" track bolt and nut or two 1/4" x 11/32" rivets.

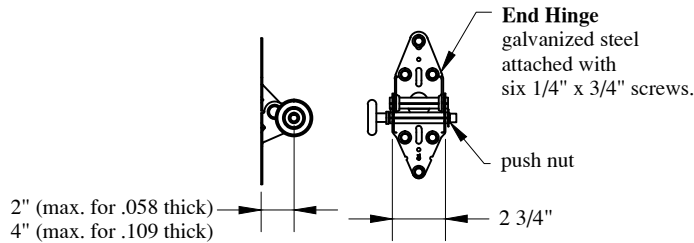

2" (max. for .058 thick)
 4" (max. for .109 thick)
 2 3/4"

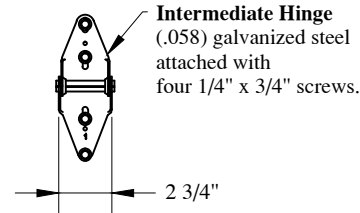

Intermediate Hinge
 (.058) galvanized steel attached with four 1/4" x 3/4" screws.
 2 3/4"

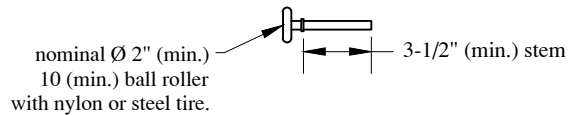

nominal Ø 2" (min.)
 10 (min.) ball roller with nylon or steel tire.
 3-1/2" (min.) stem

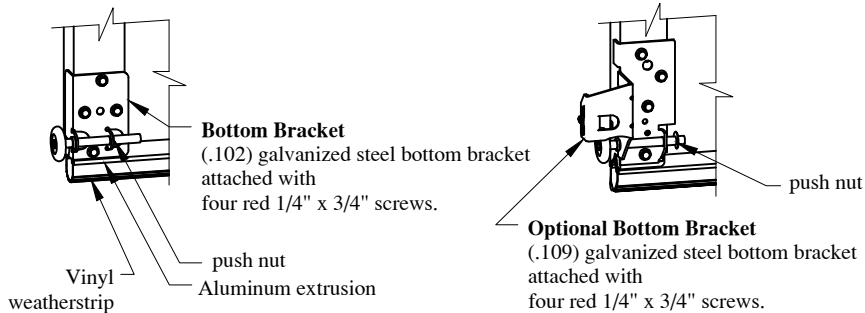

Bottom Bracket
 (.102) galvanized steel bottom bracket attached with four red 1/4" x 3/4" screws.

Optional Bottom Bracket
 (.109) galvanized steel bottom bracket attached with four red 1/4" x 3/4" screws.

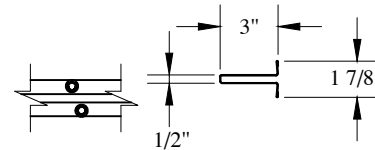

Strut and Strut Attachment
 (.051) 50 ksi galvanized steel 3" strut attached with two 1/4" x 3/4" screws per stile.

John E. Scates, P.E.
 2560 King Arthur, Ste 124-54
 Lewisville, Texas 75056
 TXPE 56308, F-2203
 Florida P.E. # 51737

Professional Engineer's seal provided only for verification of windload construction details

C.H.I.	SCALE	nts
	DATE	03-10-2022
Model Series: Rib Doors, Commercial		
C.H.I. Drawing: Z8i-10-61517		
page 5 of 5		