

BILL OF MATERIALS FOR HINGED PATIO DOOR OF 6'1" HEIGHT-OUTSWING (Water=DP70)

ITEM	NO.	QTY	PART DESCRIPTION	MATERIALS
FRAME	1	6	HEAD FRAME & JAMB	FOAM PVC CO-EX
	2	2	OUTSWING SILL-A	FOAM PVE CO-EX
	11	2	OUTSWING SILL-B	ALUMINUM
	18	2	WEATHER STRIP(A)	PP & TPE
	19	6	WEATHER STRIP(B)	FOAM PU ,PE FILM, ELON
	27	6	DOOR HINGE	STEEL
	20	2	CORNER PAD	FOAM PU ,PE FILM
	33	2	TOP/BOTTOM BAR KEEPER	STAINLESS STEEL
	21	4	DOOR/LITE FRAME	FOAM PVC
	22	4	DOOR GAP PLANK	FOAM PVC
	16	1	MULLION COVER (B)	FOAM PVC
	17	1	REINFORCEMENT (B)	ALUMINUM
	35	1	SILL RISER	ALUMINUM
	50	34	#10 X 3" PHILLIPS FLAT HEAD	SHEET METAL
	51	22	#10 X 2 1/2" PHILLIPS FLAT HEAD	SHEET METAL
	52	21	#10 X 2" PHILLIPS FLAT HEAD	SHEET METAL
	3	6	STYLE-(A)	FOAM PVC
	4	1	STYLE-(B)	FOAM PVC
	5	1	STYLE-(C)	FOAM PVC
	6	8	TOP & BOTTOM RAIL	FOAM PVC
	7	7	REIN. WOOD-(A)	WOOD
	8	1	REIN. WOOD-(B)	WOOD
	9	16	REIN. WOOD-(C)	WOOD
	10	4	REIN. WOOD-(D)	WOOD
	12	2	DOOR BOTTOM-(A)	RIGID PVC CO-EX
	13	2	DOOR BOTTOM-(B)	RIGID PVC CO-EX
	14	2	ASTRAGL (A)	RIGID PVC
	15	2	REINFORCEMENT	ALUMINUM
	24	2	ASTRAGL TOP CAP	RIGID PVC
	25	2	ASTRAGL BOTTOM CAP	RIGID PVC
	23	2	DRIVE BAR PLATE	STAINLESS STEEL
	28	2	FLUSH BOLT BAR	STAINLESS STEEL
	29	2	FLUSH BOLT MECHANISM	DIE CAST STEEL, POM
	30	1	MULTI-POINT LOCKING SYSTEM	STEEL
	31	1	HANDLE SETS	DIE CASE
32	2	HEAVY HOOK KEEPER	STAINLESS STEEL	
34	1	SLAB MULTI-POINT LOCK KEEPER	STAINLESS STEEL	
40	8	Sheet Molding Compound SKIN	FIBERGLASS	
52	36	#10 X 2" PHILLIPS FLAT HEAD	SHEET METAL	
53	4	#10 X 7/8" PHILLIPS FLAT HEAD	SHEET METAL	
54	4	#9 X 1 1/2" PHILLIPS FLAT HEAD	SHEET METAL	
55	4	#9 X 7/8" PHILLIPS FLAT HEAD	SHEET METAL	

ACTIVE, PASSIVE,
AND
STATIONARY
PANEL (A4P)

TEST SPECIMEN COMPLIES WITH THESE DETAILS ANY DEVIATION IS NOTED.
REPORT NO. NCTL - 210 - 4112-03
TEST DATE: 07/20/18

DATE	AUG/02/2018	SHEET	6'1" Height Outswing Patio Door OXXX
DRAWN BY	Ruskin Wu	1 of 12	Bill of Materials (Water=DP70)
DWG NO.			
REVISIONS			

TEST SPECIMEN COMPLIES WITH THESE DETAILS. ANY DEVIATION IS NOTED.

REPORT NO. NCTL - 210 - 4112-03

TEST DATE: 07/26/18

146 7/16" [3719.5]

UNIT DIM=109 1/16" [2770.2]

37 3/8" [949.3]

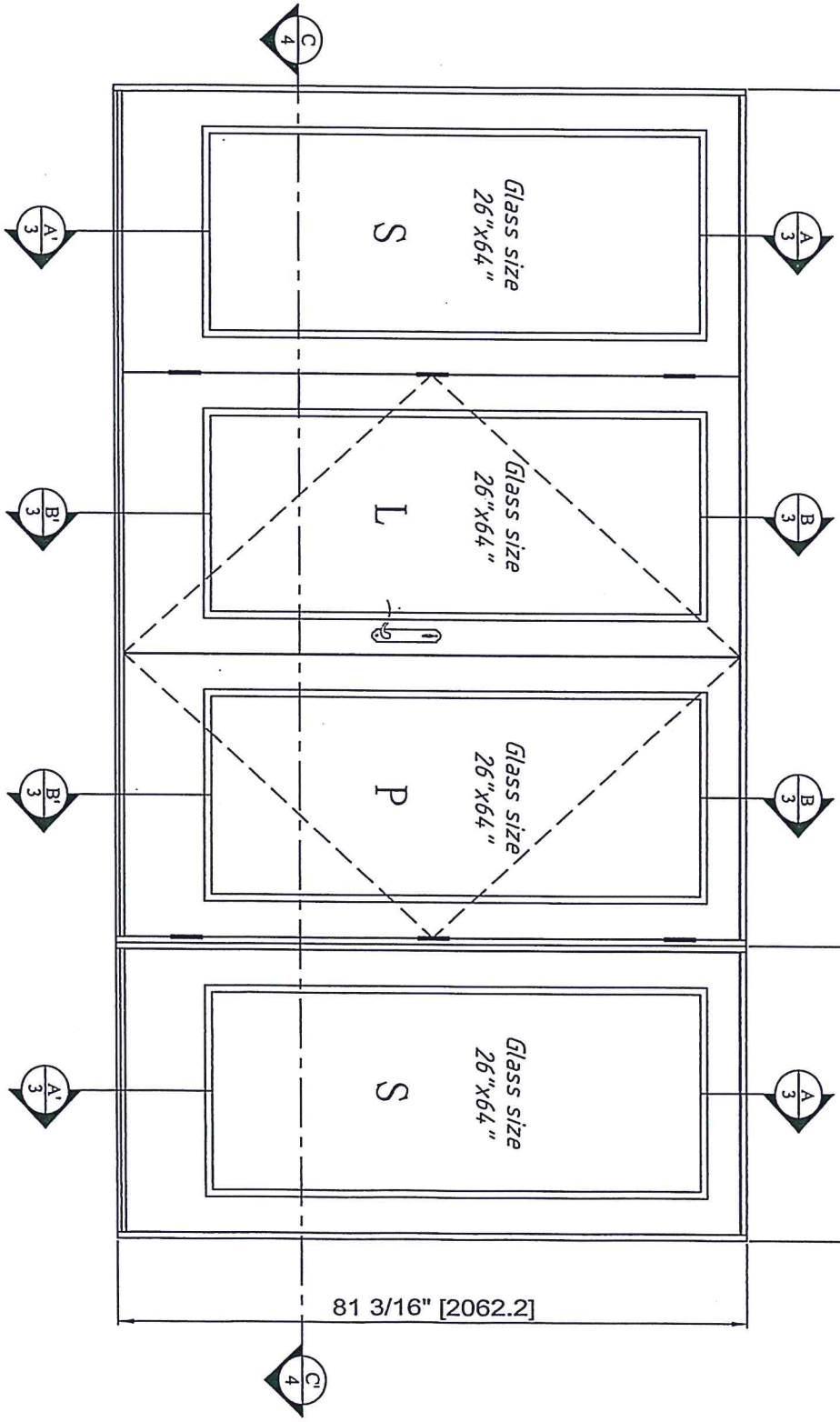

Exterior view shown
 S: Stationary
 L: Active panel of hinge at left side
 P: Passive panel

6'1 1/4" Height Outswing (146 7/16"X81 3/16")
 AAMA A440-11 & A440S1-17 / ASTM E1886 / ASTM E1996 / TAS201,202,203

DATE	Aug/02/2018	SHEET	SHEET TITLE:	
DRAWN BY	Ruskin Wu	2 of 12	6'1 1/4" Height Outswing Patio Door OXO (146 7/16" X 81 3/16")	
REVISIONS	DWG NO. -			

NAN YA PLASTICS CORPORATION
 6FL, 201, Tunj Pkwn N, Road Tjilolei, Taman
 Tel: (609)2-2712-2211 : Fax: (609)2-2717-4512

COMPLIES

A Frame Head
Stationary

4 9/16" [115.9]

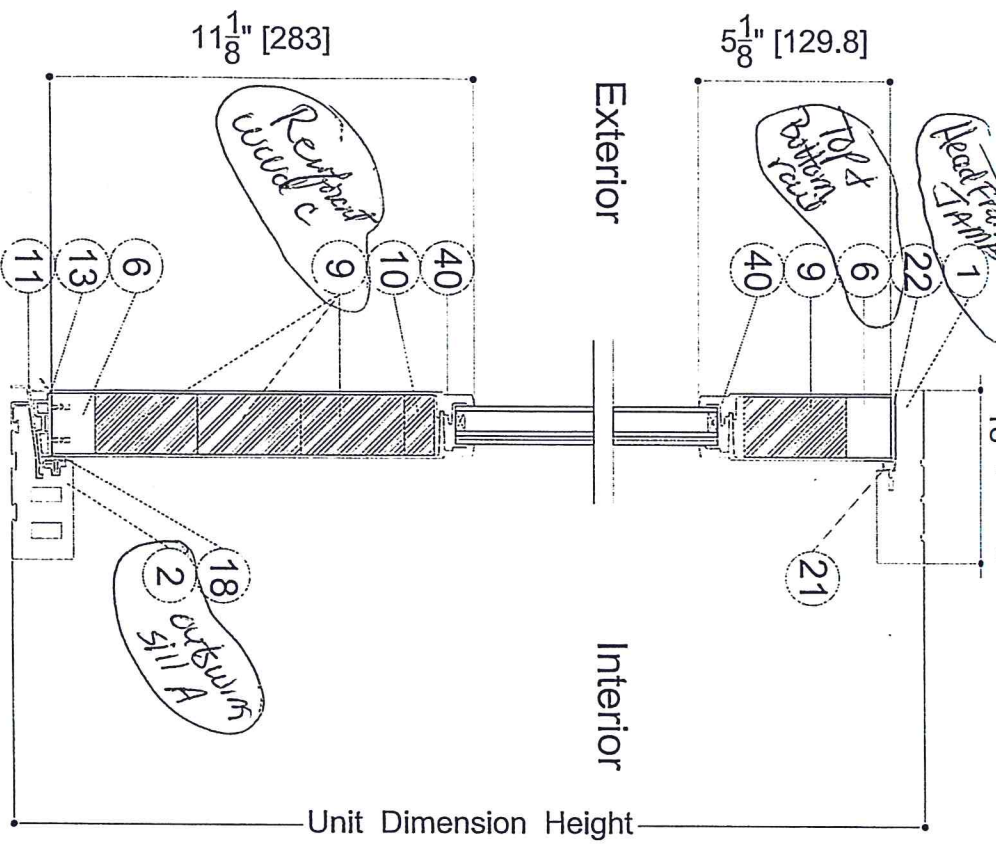

WITH THESE DETAILS. ANY
DEVIATION IS NOTED.
REPORT NO. NCTL - 210 - 4/17-03
TEST DATE: 07/20/15

B Frame Head
Active/Passive

4 9/16" [115.9]

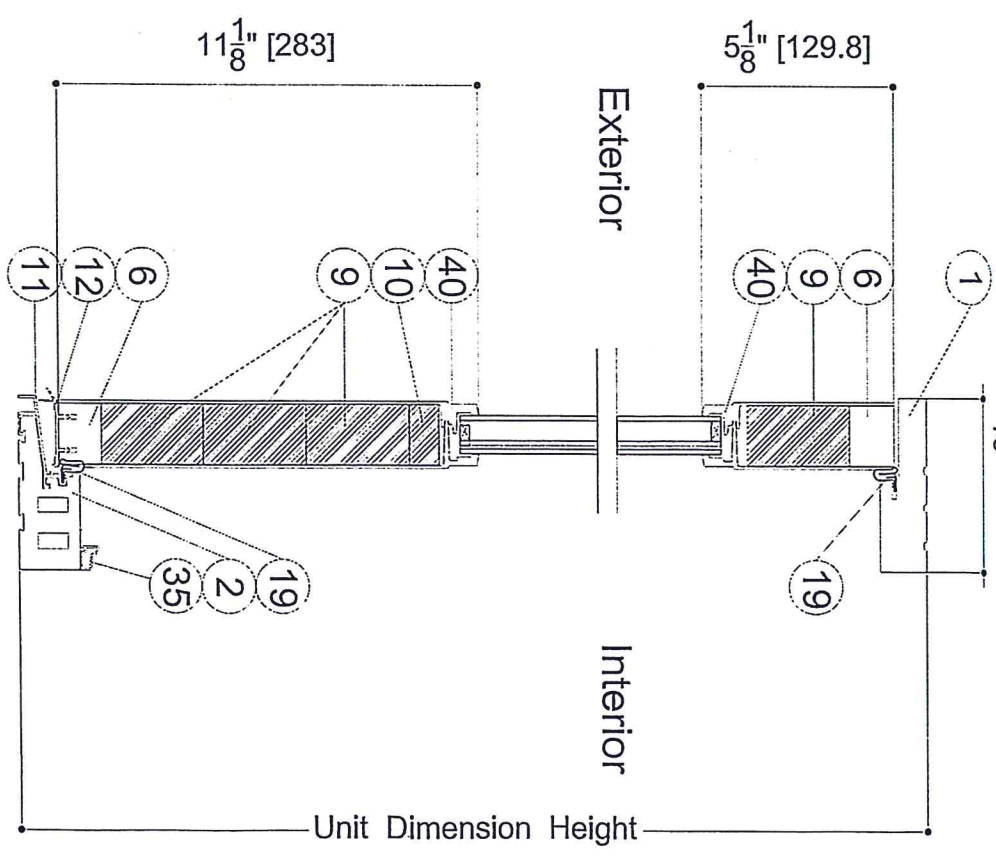

A' Threshold
Stationary

B' Threshold
Active/Passive

DATE	Aug/02/2018	SHEET	3 of 12	SHEET TITLE:	6'1 1/2" Height Outswing Patio Door OXXX A-A' & B-B' Vertical Section (Water=DP70)
DRAWN BY	Ruskin Wu				
DWG NO.					
REVISIONS					

Triple Doors Unit Dim. Width

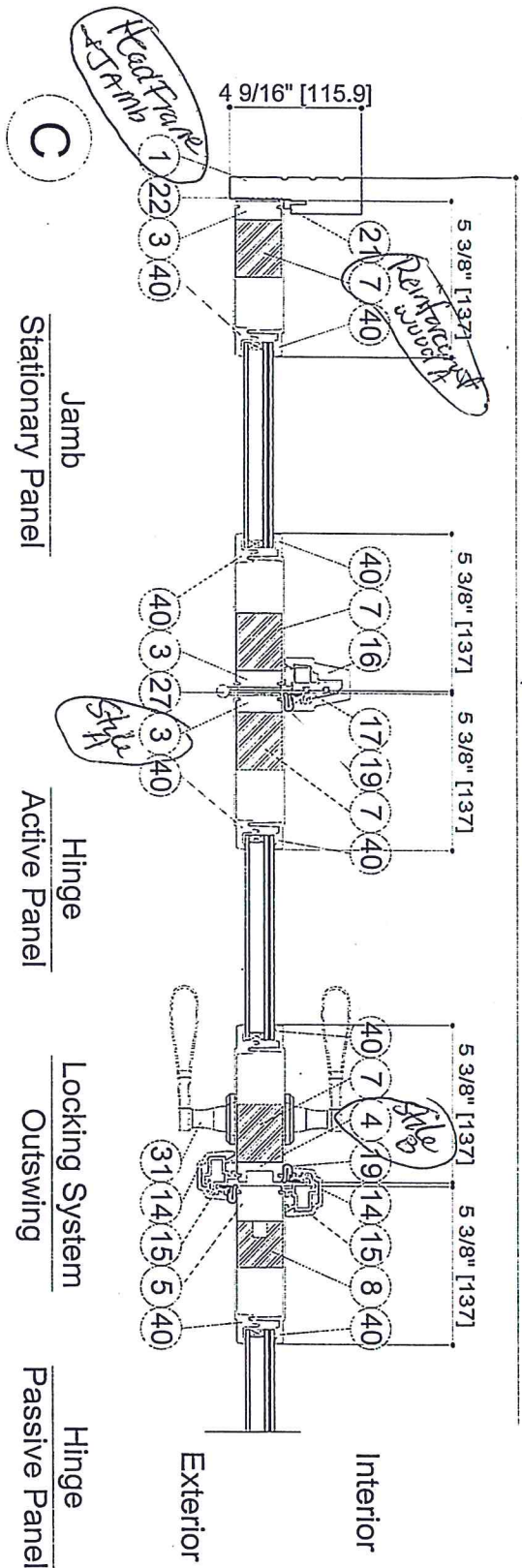

Triple Doors Unit Dim. Width

Single Door Unit Dim. Width

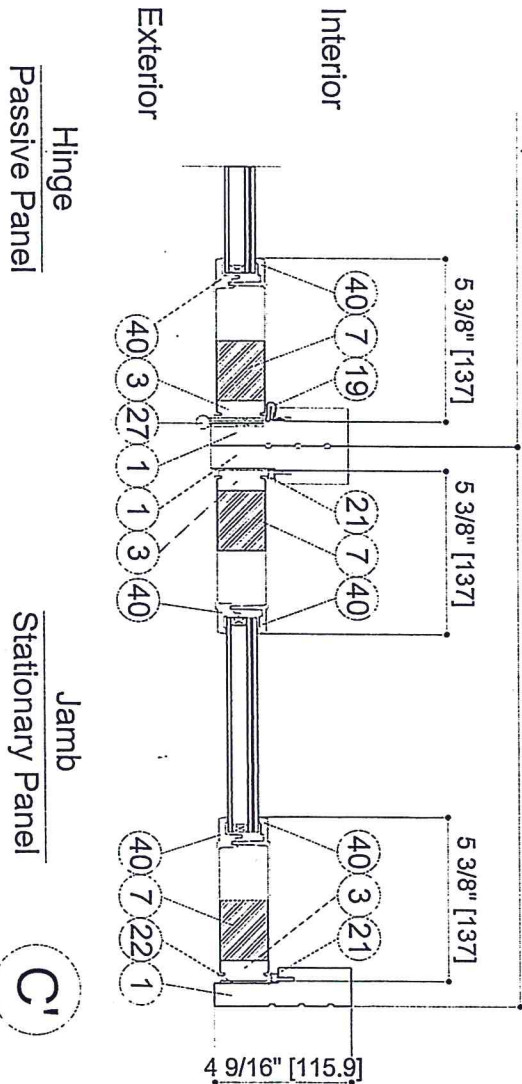

1. DRAWING COMPLIES WITH THESE DETAILS. ANY DEVIATION IS NOTED. REPORT NO. NCTL - 210 - 4112-03 TEST DATE: 07/20/18

DATE	Aug/02/2018	SHEET	4 of 12	SHEET TITLE:	6'1" Height Outswing Patio Door OXXO C-C' Horizontal Section (Water=DP70)
DRAWN BY	Ruskin Wu				
DWG NO.					
REVISIONS					

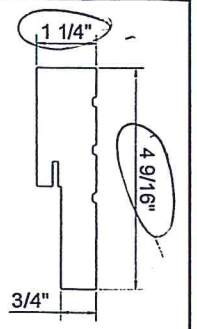

1 HEAD FRAME & JAMB
FOAM PVC CO-EX.

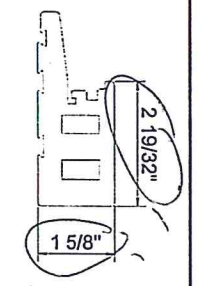

2 OUTSWING SILL-(A)
FOAM PVC CO-EX.

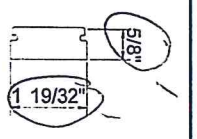

3 STILE-(A)
FOAM PVC

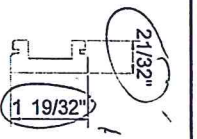

4 STILE-(B)
FOAM PVC

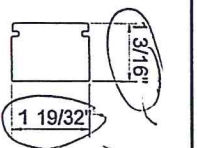

5 STILE-(C)
FOAM PVC

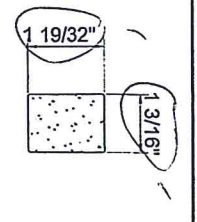

6 TOP & Bottom RAIL
FOAM PVC

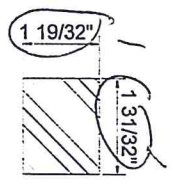

7 REIN. WOOD-(A)
Wood

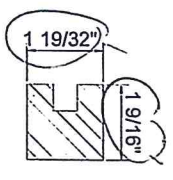

8 REIN. WOOD-(B)
Wood

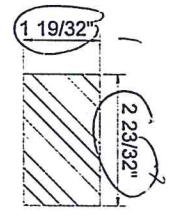

9 REIN. WOOD-(C)
Wood

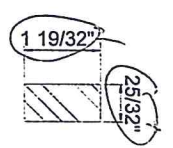

10 REIN. WOOD-(D)
Wood

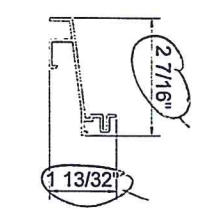

11 OUTSWING SILL-(B)
ALUMINIUM

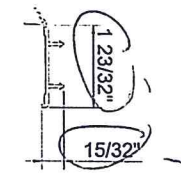

12 DOOR BOTTOM-(A)
RIGID PVC CO-EX

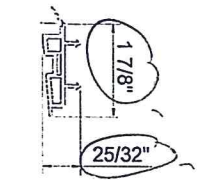

13 DOOR BOTTOM-(B)
RIGID PVC CO-EX

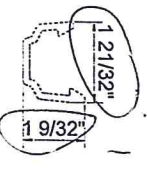

14 ASTRAGAL (A)
RIGID PVC

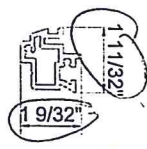

15 REINFORCEMENT(A)
ALUMINIUM

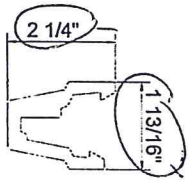

16 MULLION COVER (B)
FOAM PVC

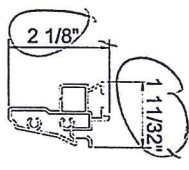

17 REINFORCEMENT (B)
ALUMINIUM

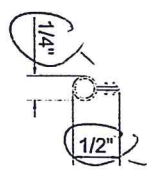

18 WEATHER STRIP(A)
PP&TPE

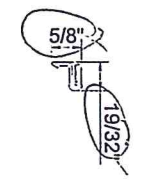

19 WEATHER STRIP(B)
FOAM PU ,PE FILM, E LON

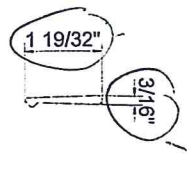

20 CORNER PAD
FOAM PU ,PE FILM

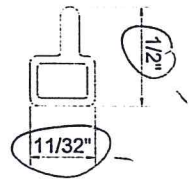

21 DOORLITE FRAME
FOAM PVC

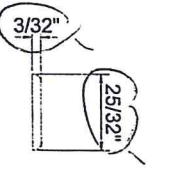

22 DOOR GAP PLANK
FOAM PVC

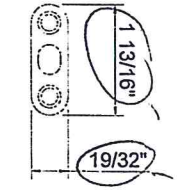

23 DRIVE BAR PLATE
STAINLESS STEEL

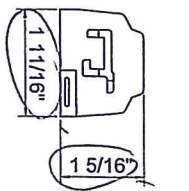

24 ASTRAGAL TOP CAP
RIGID PVC

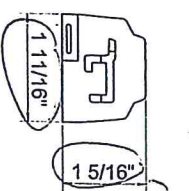

25 ASTRAGAL BOTTOM CAP
RIGID PVC

TEST SPECIMEN COMPLIES

WITH THESE DETAILS

DEVIATION IS NOTED

REPORT NO. 210 4/17-03

TEST DATE: 07/20/18

SHEET 5 of 12

6'1 1/2\"/>

Door Hardware & Accessories (Water=DP70) -1

NAN YA PLASTICS CORPORATION
6FL, 201, Tung Hwa N. Road Taipei, Taiwan
Tel: (886)2-2712-2211 Fax: (886)2-2717-4552

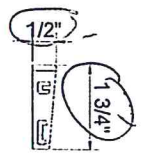

26 BOTTOM CAP(LR)
RIGID PVC

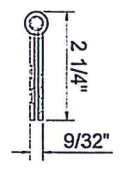

27 DOOR HINGE
STEEL

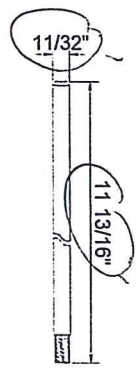

28 FLUSH BOLT BAR
STAINLESS STEEL

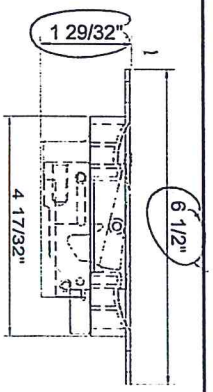

29 FLUSH BOLT MECHANISM
DIE CAST, STEEL, POM

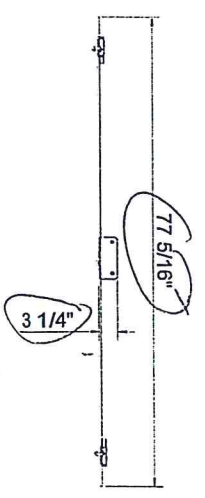

30 MULTI-POINT LOCKING SYSTEM
STAINLESS STEEL, STEEL

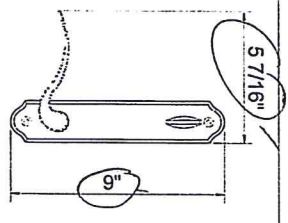

31 HANDLE SETS
DIE CAST

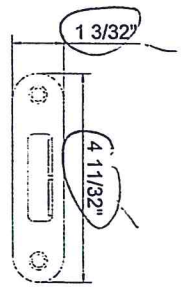

32 HEAVY HOOK KEEPER
STAINLESS STEEL

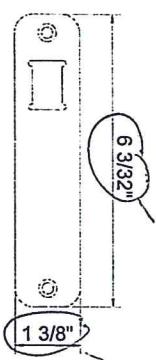

33 TOP/BOTTOM BAR KEEPER
STAINLESS STEEL

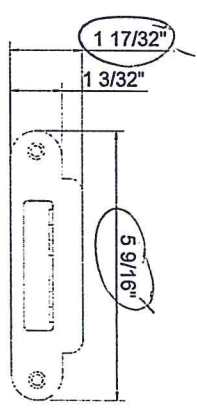

34 SLAB MULTI-POINT LOCK KEEPER
STAINLESS STEEL

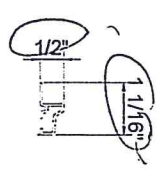

35 SILL RISER
ALUMINUM

TEST SPECIMEN COMPLIES WITH THESE DETAILS. ANY DEVIATION IS NOTED.
REPORT NO. NOTL - 210 - 4112-03
TEST DATE: 07/20/18

DATE	AUG/02/2018	SHEET	6 of 12	SHEET TITLE:	6'1 1/2" Height Outswing Patio Door OXXO Door Hardware & Accessories (Water=DP70) -2
DRAWN BY	Ruskin Wu				
DWG NO.					
REVISIONS					

6'1" A4P Outswing Active Panel Details

Door Slab Size: 35 3/4" X 79 1/4"

Glass : 26" X 64"

D.O : 25" X 63"

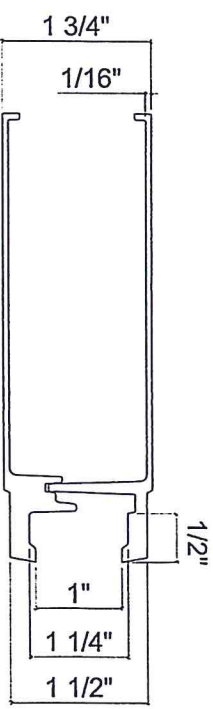
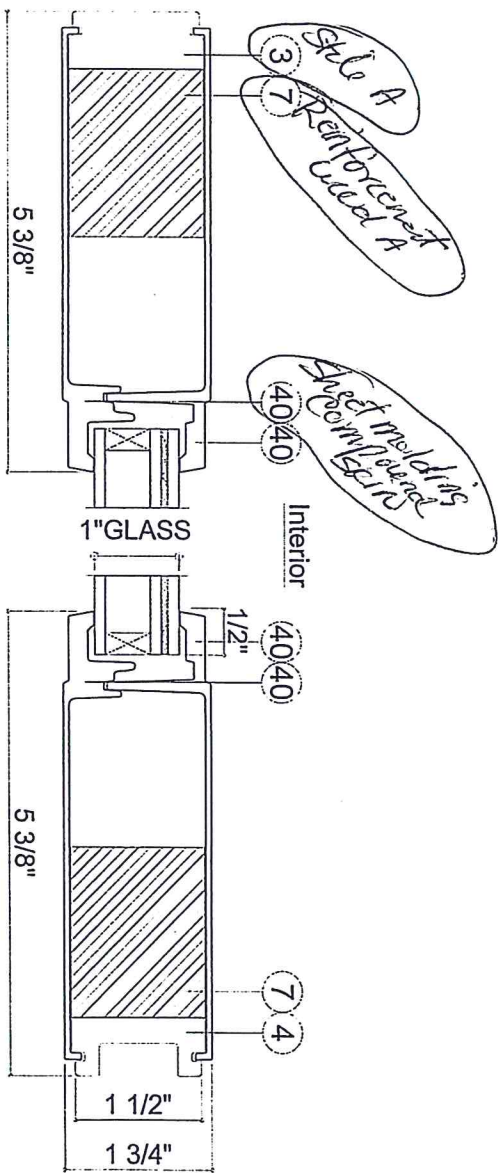
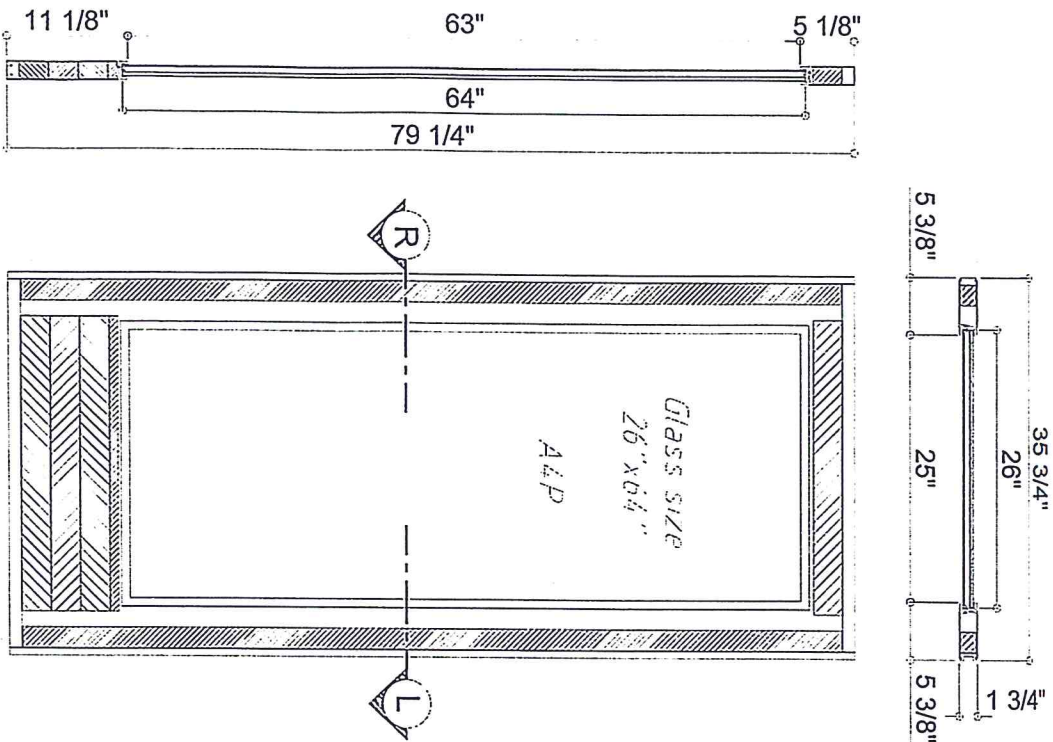

LET SUPPLIER COMPARE WITH THESE DETAILS. ANY DEVIATION IS NOTED. REPORT NO. NCTL - 210 - 4112-03 TEST DATE: 07/20/18

REVISIONS	DATE	DRAWN BY	DWG NO.	SHEET	SHEET TITLE:
	Aug/02/2018	Ruskin Wu		7 of 12	6'1" Height Outswing Patio Door OXXX Active Panel Door

6'1 1/2" A4P Outswing Passive Panel Details

Door Slab Size: 35 3/4" X 79 1/4"

Glass : 26" X 64"

D.O : 25" X 63"

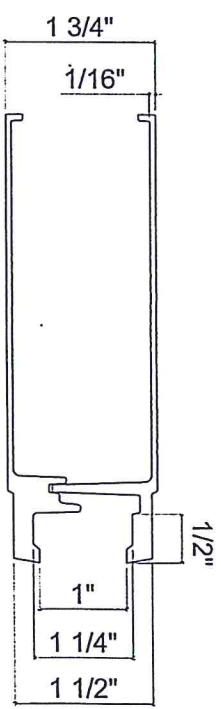
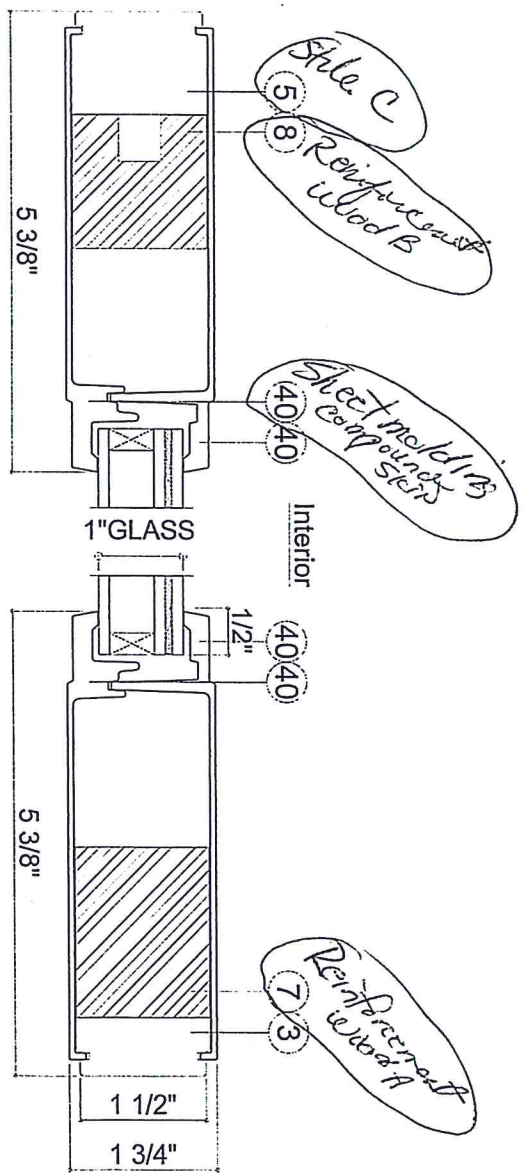
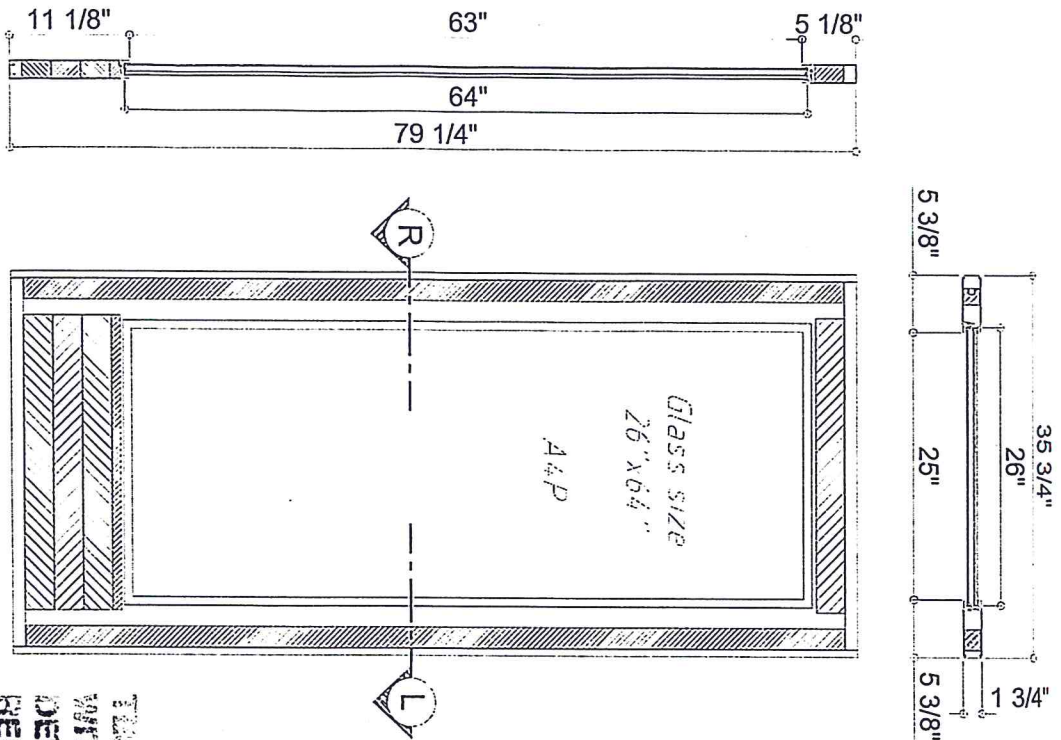

THIS DOCUMENT COMPLIES WITH THESE DETAILS. ANY DEVIATION IS NOTED.
 REPORT NO. NCTL - 210 - 4112-03
 TEST DATE: 07/20/18

REVISIONS	DATE	DRAWN BY	DWG NO.
	Aug/02/2018	Ruskin Wu	
SHEET TITLE: 6'1 1/2" Height Outswing Patio Door OXXO			
SHEET: 8 of 12			
Passive Panel Door			
NAN YA PLASTICS CORPORATION 6F, 201, Tung Hwa N. Road Taipei, Taiwan Tel: (886)2-2712-2211 ; Fax: (886)2-2717-6512			

6'1" A4P Outswing Stationary Panel Details

Door Slab Size: 35 3/4" X 79 1/4"

Glass : 26" X 64"

D.O : 25" X 63"

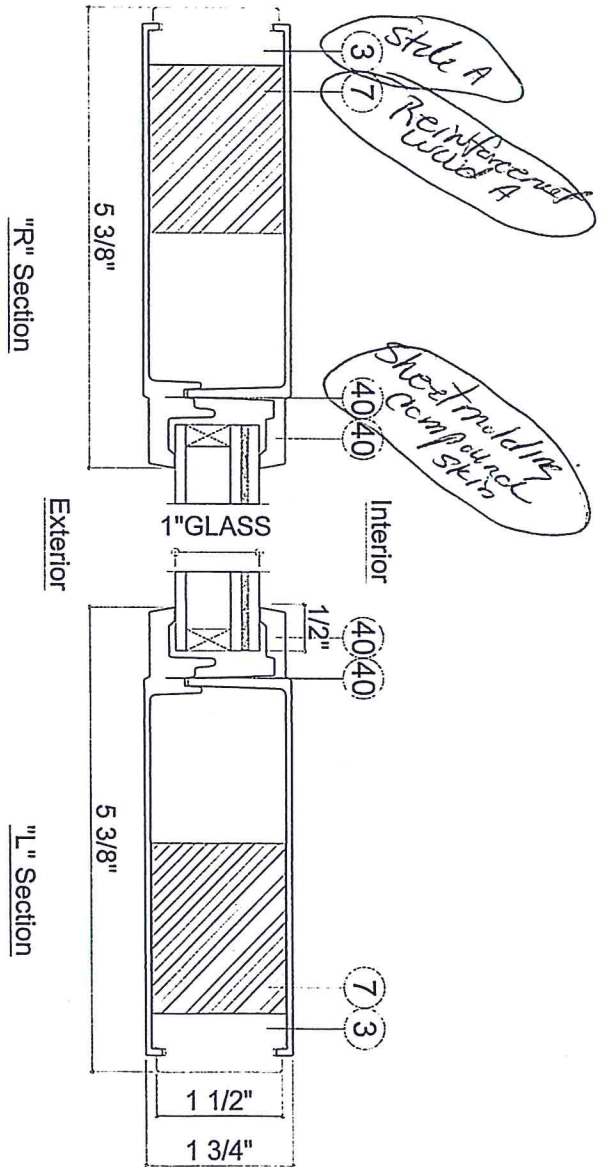
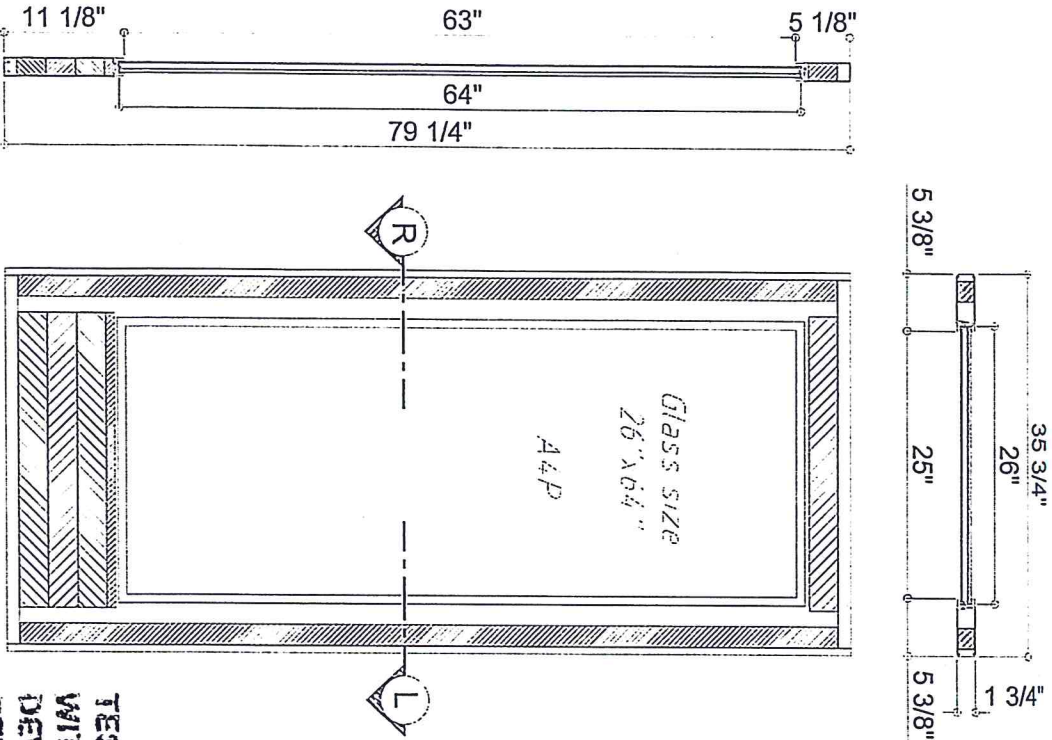

TEST SPECIMEN COMPLIES WITH THESE DETAILS. ANY DEVIATION IS NOTED.
 REPORT NO. NCTL - 210 - 4/12-03
 TEST DATE: 07/20/18

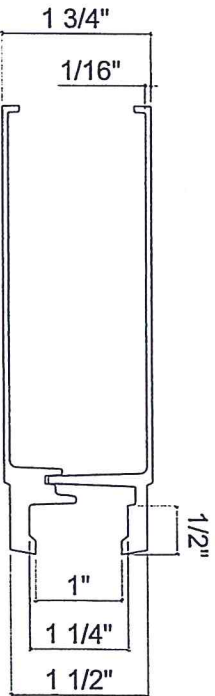

REVISIONS	DATE	DRAWN BY	DWG NO.	Aug/02/2018	Ruskin Wu
	SHEET	SHEET TITLE:		9 of 12	6'1" Height Outswing Patio Door OXXO Stationary Panel Door
NAN YA PLASTICS CORPORATION GFL 201, Tung Hua N. Road Taipei, Taiwan Tel: (886)2-2712-2211 ; Fax: (886)2-2717-6512					

TEST SPECIMEN COMPLIES WITH THESE DETAILS. ANY DEVIATION IS NOTED.

REPORT NO. MCTL - 210 - 4/12-03
 TEST DATE: 07/26/18

(14) ASTRAGAL(A) FOR PASSIVE PANEL IN INTERIOR

77.21/32"

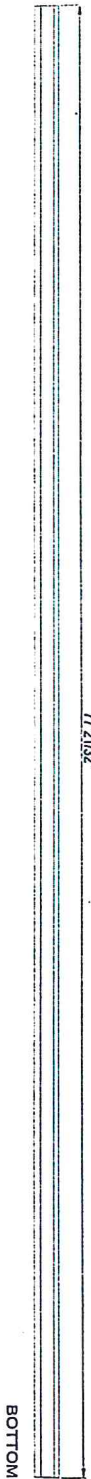

(14) ASTRAGAL(A) FOR ACTIVE PANEL IN EXTERIOR

78.11/16"



(15) REINFORCEMENT(A) FOR PASSIVE PANEL IN INTERIOR

77.5/8"

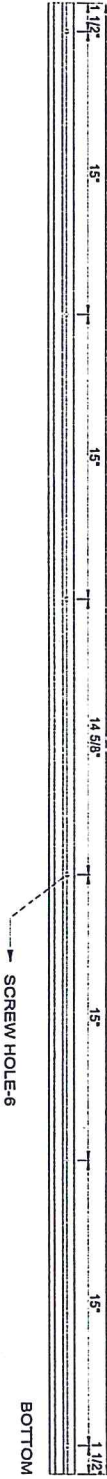

(15) REINFORCEMENT(A) FOR ACTIVE PANEL IN EXTERIOR

78.21/32"



(16) MULLION COVER(B)

78.5/16"

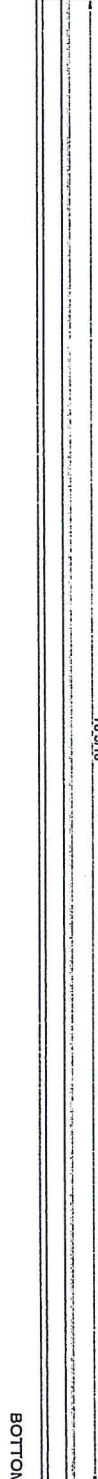

(17) REINFORCEMENT(B)

78.5/16"



DATE	AUG/02/2018	SHEET	10 of 12	SHEET TITLE:	6'1 1/2" Height Outswing Patio Door OXXXO Astragal Specification	 NAN YA PLASTICS CORPORATION 0F1-201, Tun0 Hwa N, Road Taipei, Taiwan Tel:(886)2-2712-2211 : Fax:(886)2-2717-0512
DRAWN BY	Ruskin Wu	DWG NO.		REVISIONS		

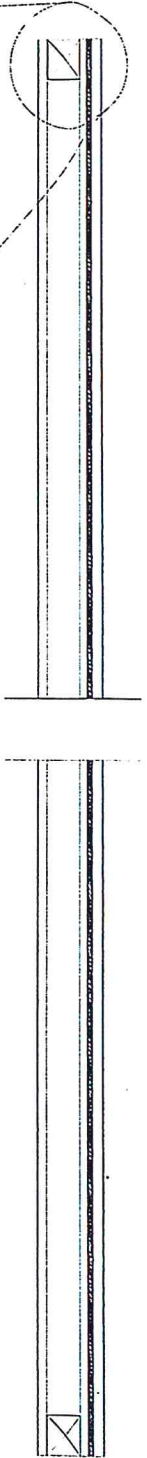

Interior

Exterior

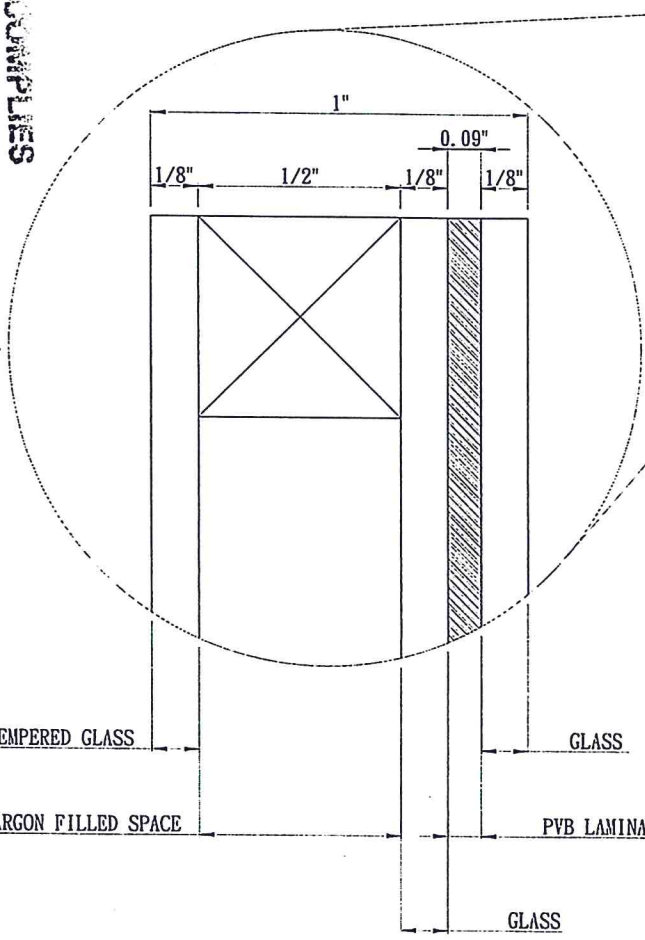

THIS DRAWING COMPLIES WITH THESE DETAILS. ANY DEVIATION IS NOTED. REPORT NO. NCTL - 210 - 4112-03 TEST DATE: 07/20/18

REVISIONS	DATE	DRAWN BY	DWG NO.	DATE	DRAWN BY	DWG NO.	SHEET	SHEET TITLE:
	Aug/02/2018	Ruskin Wu	-	Aug/02/2018	Ruskin Wu	-	11 of 12	1" Laminated Glass Consisting

ANCHORING FOR 6'11" OUTSWING FOUR PANEL DOOR (OXXX) TO THE WOOD BUCK

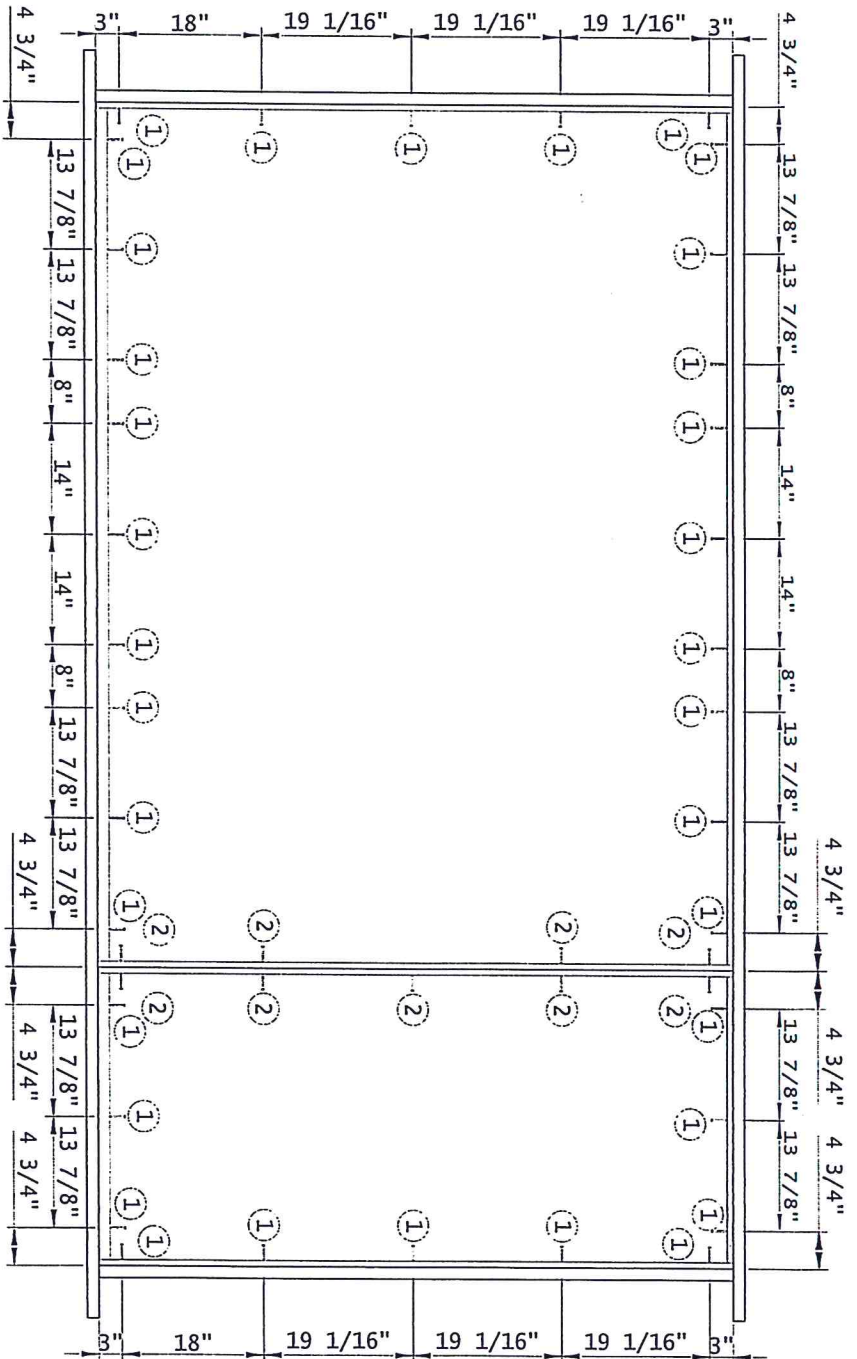

SCREW SCHEDULE

ITEM	MATERIALS	QTY
①	#10 X 3" PHILLIPS SQUARE DRIVE SCREWS	34
②	#10 X 2" PHILLIPS SQUARE DRIVE SCREWS	9

TEST SPECIMEN COMPLIES WITH THESE DETAILS. ANY DEVIATION IS NOTED.
REPORT NO. NCTL - 210 - 4112-03
TEST DATE: 07/20/18

DATE	Aug/02/2018	SHEET	12 of 12	SHEET TITLE:	6'11" Outswing Four Panel Door (OXXX) To Wood Buck Screw Schedule
DRAWN BY	Ruskin Wu				
DWG NO.					
REVISIONS					



NAN YA PLASTICS CORPORATION
 6F1, 201, Tung Hwa N. Road Taipei, Taiwan
 Tel: (886) 2-2712-2111 ; Fax: (886) 2-2717-9512