

Item	PART No.	ITEM DESCRIPTION	MANUFACTURERS
1	7002	Head	P.H. Tech
2	9785	No. 8 x 2" Truss head, Quadrex screw	P.H. Tech
3	9550	Weatherstrip	See #99922/023-49-01 Anemary #230270456YGDH Schlegel #HF7822-270
4	9728	Mobile Sash Anchor Block	P.H. Tech
5	7206.M	Mobile Vertical Roll	P.H. Tech
6	8933	Glazing block	P.H. Tech
7		Silicone structural adhesive	Silo 502
8		Laminated Glass	Various
9	7541	Shim	P.H. Tech
10	9732	Tandem wheel	P.H. Tech
11	9790	Rolling roll	P.H. Tech
12	7000	Shim	P.H. Tech
13	8723	Shim dust cover	P.H. Tech
14	9734	Shim plug	P.H. Tech
15	710	Shim weatherseal	P.H. Tech
16	9905	Wedge hole cover	P.H. Tech
17	9885	Outside mobile sash support gasket	P.H. Tech
18	8789	Outside mobile sash gasket	P.H. Tech
19	9887	No. 9 x 5/8", pan head, square, self-drilling screw	P.H. Tech
20	9991	Outside sill casting	P.H. Tech
21		Sealant	Various
22	9599	Insect stop	P.H. Tech
23		Screen	P.H. Tech
24	7506	Meat stile	P.H. Tech
25	9599	Steel reinforcement	P.H. Tech
26	9785	No. 8 x 2", truss head, Quadrex, screw	P.H. Tech
27	8913	Recess handle	P.H. Tech
28	5770	Glazing bead	P.H. Tech
29	9853	Foam plug	P.H. Tech
30	703	Head weatherseal	P.H. Tech
31	8941	No. 8 x 1 1/4", pan head, Quadrex, screw	P.H. Tech
32	8940	Sash stopper	P.H. Tech
33	9580	Weatherstrip	P.H. Tech
34	7004.D	Left jamb	P.H. Tech
35	9371	Weatherstrip	P.H. Tech
36	7597.M	Outside mobile panel side stile	P.H. Tech
37	9598	Steel reinforcement	P.H. Tech
38	9555	Insect stop	P.H. Tech
39		Handle kit	P.H. Tech
40	7287.M	Inside mobile panel side stile	P.H. Tech
41	7011	Mobile panel support	P.H. Tech
42	8980	Keeper for screen	P.H. Tech
43	8982	No. 8 x 5/8", pan head, Quadrex, screw	P.H. Tech
44	7004.D	Right jamb	P.H. Tech
45	8942.SS	No. 10 x 2", pan head, Philips, stainless steel screw	P.H. Tech
46	9250.SS	Stainless steel double point mortise lock kit	P.H. Tech
47	7363	Sash covering cap	P.H. Tech
48	8150	Lock plug	P.H. Tech
49	8536	Weatherstop	P.H. Tech
50	8055	Water bar	P.H. Tech
51	9797	No. 8 x 1", pan head, Philips, stainless steel screw	P.H. Tech
52	9987	Screw cap	P.H. Tech

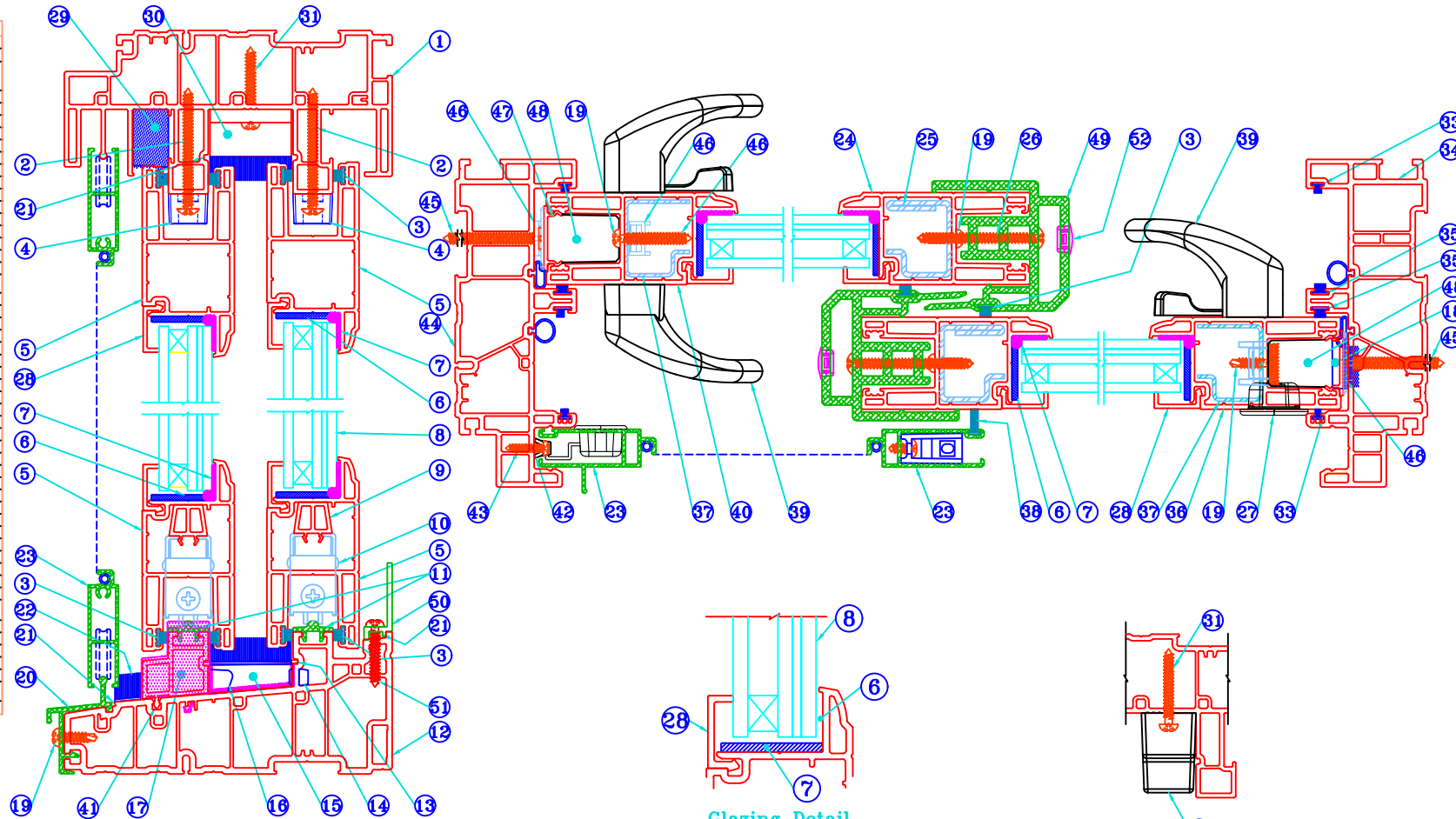

**Glazing Detail**  
 Laminated glass 7/8" overall thickness  
 clear insulated glass consisting of:  
 - 5/32" Tempered - 5/16" Air space  
 - 5/32" Annealed - 0.090" PVB  
 - 5/32" Annealed).  
 Endur spacer.

**Sash Stopper Detail**

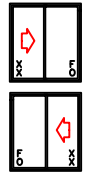

**Molimo**<sup>TM</sup>  
 Architectural Product Testing  
 Report #: 12006.09-106-12  
 Date: 2/24/2023  
 By: M. Stremmel, P.E.

MATERIAL:		MI WINDOWS AND DOORS, LLC. 650 WEST MARKET STREET GRATZ, PA 17030-0370	DESCRIPTION: 1615 Glass Door Vert and Horiz cross section XX Impact Bill of Material		
FINISH:			UNSPECIFIED WALL:	PRODUCT: 1615 - SGD	DATE: 8/9/22
AREA:			BREAK ALL CORNERS R.015, UNLESS OTHERWISE SPECIFIED	SCALE: Full	PART NUMBER:
WEIGHT:				DFTM: BAK	DRAWING NUMBER: CS-000736
LTR	ECN #	REVISIONS	DATE	BY	PERIMETER:

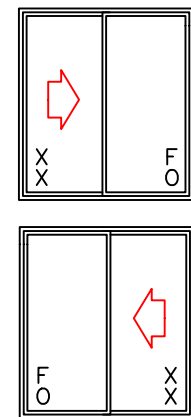
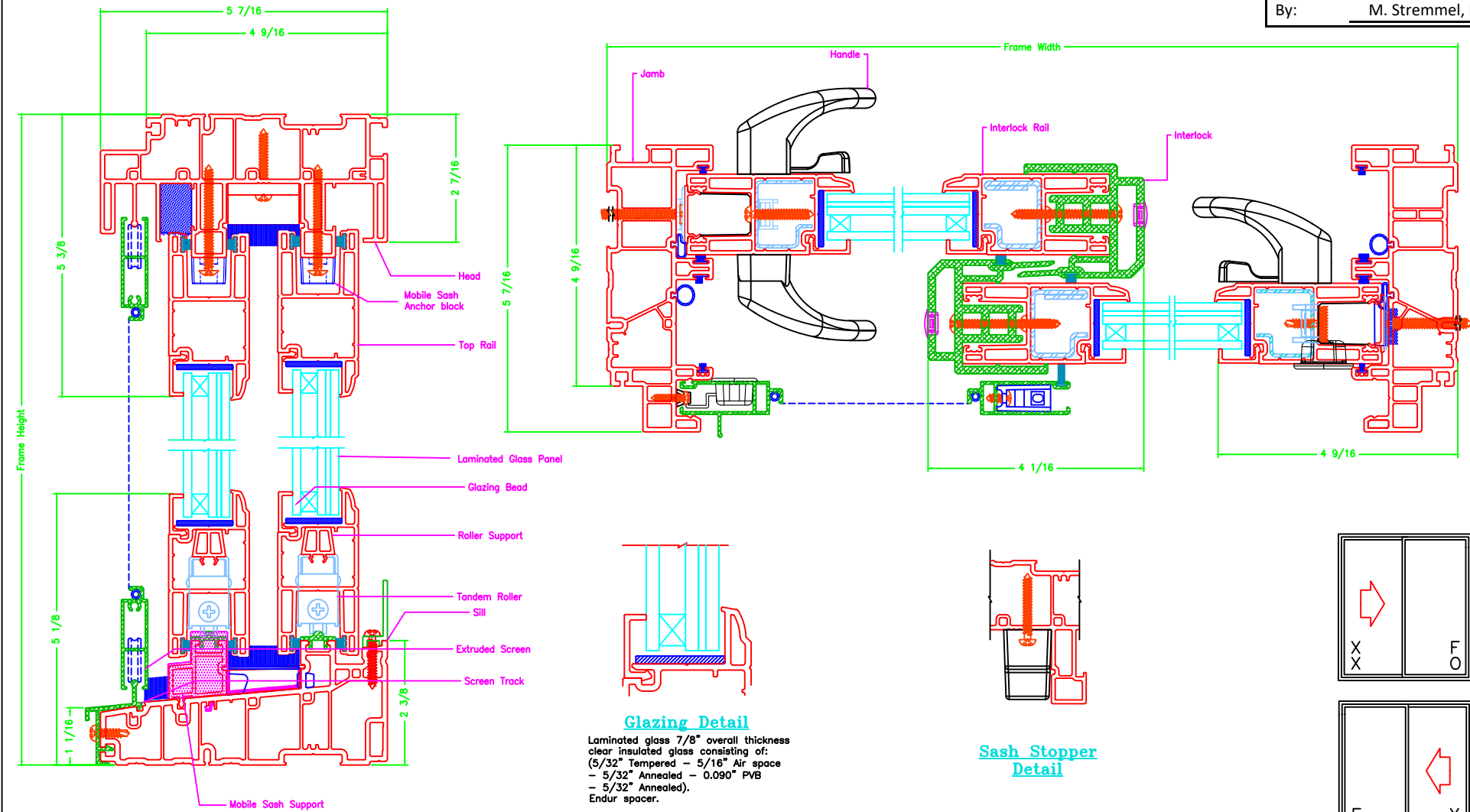

			<b>MATERIAL:</b> FINISH: UNSPECIFIED WALL: AREA: WEIGHT: PERIMETER:		 <b>MI WINDOWS AND DOORS, LLC.</b> 650 WEST MARKET STREET GRATZ, PA 17030-0370	<b>DESCRIPTION:</b> Sliding Glass Door XX Impact Door Cross Section		
			BREAK ALL CORNERS R.015, UNLESS OTHERWISE SPECIFIED			The information, design or data shown on this document or electronic media is the exclusive property of MI Windows and Doors, LLC. It is considered confidential and proprietary and is made available for limited use only. Its use or reproduction without the expressed written consent of MI Windows and Doors, LLC., is prohibited.		
<b>PRODUCT:</b> 1615 - SGD			<b>DATE:</b> 08/09/22		<b>SCALE:</b> Full		<b>PART NUMBER:</b>	
<b>DFTM:</b> BAK			<b>DRAWING NUMBER:</b> CS-000736					

LTR	ECN #	REVISIONS	DATE	BY

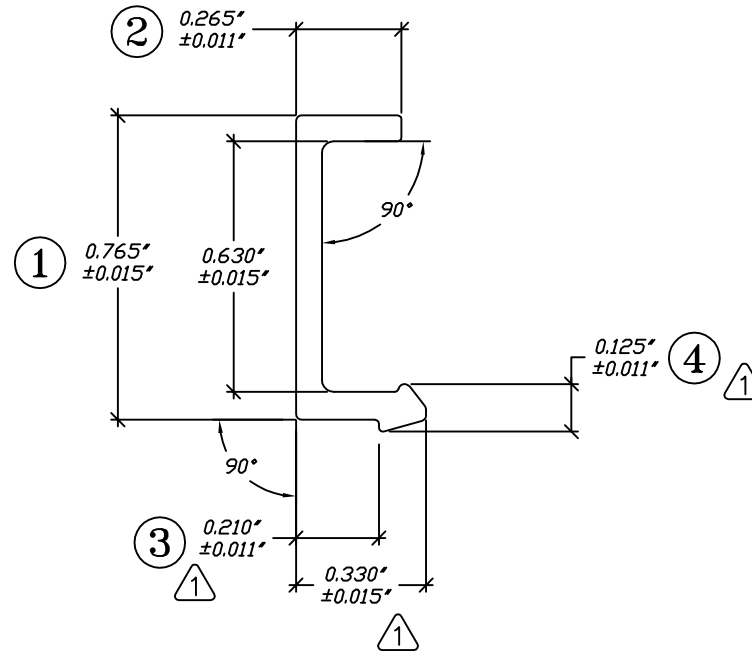

**Molimo™**  
Architectural Product Testing

Report #: 12006.09-106-12

Date: 2/24/2023

By: M. Stremmel, P.E.

RENSEIGNEMENTS FOURNIS A TITRE CONFIDENTIEL

CE DOCUMENT EST PROTEGE PAR DES DROITS D'AUTEUR. A MOINS D'UNE AUTORISATION ECRITE, IL EST INTERDIT D'UTILISER, REPRODUIRE OU DIVULGUER SON CONTENU. D'AUTRE PART, CES RENSEIGNEMENTS PEUVENT ETRE PROTEGES PAR DES SECRETS DU METIER, DES BREVETS CANADIENS OU ETRANGERS, DES ENREGISTREMENTS OU DES DEMANDES EN CE SENS. L'EMPLOI NON AUTORISE PEUT CONDUIRE A UNE VIOLATION. ON PEUT OBTENIR DES RENSEIGNEMENTS SUPPLEMENTAIRES EN FAISANT LA DEMANDE PAR ECRIT.

LE SEUL BUT DU PRESENT DOCUMENT EST DE FOURNIR DES RENSEIGNEMENTS ET NE CONSTITUE PAS UNE OFFRE DE VENTE. LA LIVRAISON OU LA PRODUCTION DU CONTENU DE CE DESSIN, ANSI QUE DE CHANGER LES DONNEES TECHNIQUES SANS PREAVIS.

L'USAGER DU PRESENT DOCUMENT RECONNAIT QUE P.H. TECH INC. ET SES REPRESENTANTS REJETENT TOUTE RESPONSABILITE EN CAS DE DOMMAGE DECULQUANT DE QUELQUE FACON QUE CE SOIT, DE L'UTILISATION DE CES RENSEIGNEMENTS.

CONFIDENTIAL PROPRIETARY INFORMATION

THIS DOCUMENT IS SUBJECT TO COPYRIGHT AND ANY USE, REPRODUCTION THEREOF OR DISCLOSURE TO OTHERS WITHOUT EXPRESS WRITTEN AUTHORIZATION IS PROHIBITED. FURTHER, THIS CONFIDENTIAL PROPRIETARY INFORMATION MAY BE PROTECTED BY TRADE SECRETS, CANADIAN OR FOREIGN PATENTS, DESIGN REGISTRATIONS OR APPLICATION FOR SUCH. ANY UNAUTHORIZED USE MAY LEAD TO INFRINGEMENT. PARTICULARS ARE AVAILABLE ON WRITTEN REQUEST.

THIS DOCUMENT IS SUPPLIED FOR INFORMATION PURPOSES ONLY AND IS NOT TO BE CONSTRUED AS AN OFFER FOR SALE. DUE TO POSSIBLE CHANGES AND IMPROVEMENTS IN DESIGN, P.H. TECH INC. RESERVES THE RIGHT TO MODIFY, CANCEL OR DISCONTINUE THE SALE, SUPPLY OR PRODUCTION OF THE CONTENTS OF THIS DRAWING OR ITS SPECIFICATIONS WITHOUT NOTICE.

THE USER OF THIS DOCUMENT ACKNOWLEDGES THAT IN NO EVENT SHALL P.H. TECH INC. OR ITS AGENTS BE RESPONSIBLE TO THE PARTY RELYING ON THIS INFORMATION, FOR DAMAGES HOWEVER CAUSED.

△			
△			
△			
△			
△			
△			
△			
△	Ajuster selon dessin Pro	JFC	10/12/01
REV.	DESCRIPTION	PAR/BY	DATE

DESSINE / DRAWN		DATE
S.P.		99/01/25
VERIFIE / VERIFIED		DATE
ECHELLE / SCALE	MURS / WALLS	TOL. GENERALES
2 = 1		S.P.I
MATERIAU/MATERIAL	REF	POIDS
	5770SPI	
	SPI/	

TITRE / TITLE	
Parclose (Verre 7/8") Glazing bead (7/8" glass)	
POIDS MAXIMUM	CODE SPI
	5770

**ph tech**™ P.H. Tech inc.  
8650 Boul. Guillaume-Couture  
Levis, Quebec Canada, G6V 9G9  
Tel.: (418) 833-3231  
Fax: (418) 833-6847



**Molimo™**  
Architectural Product Testing

Report #: 12006.09-106-12

Date: 2/24/2023

By: M. Stremmel, P.E.

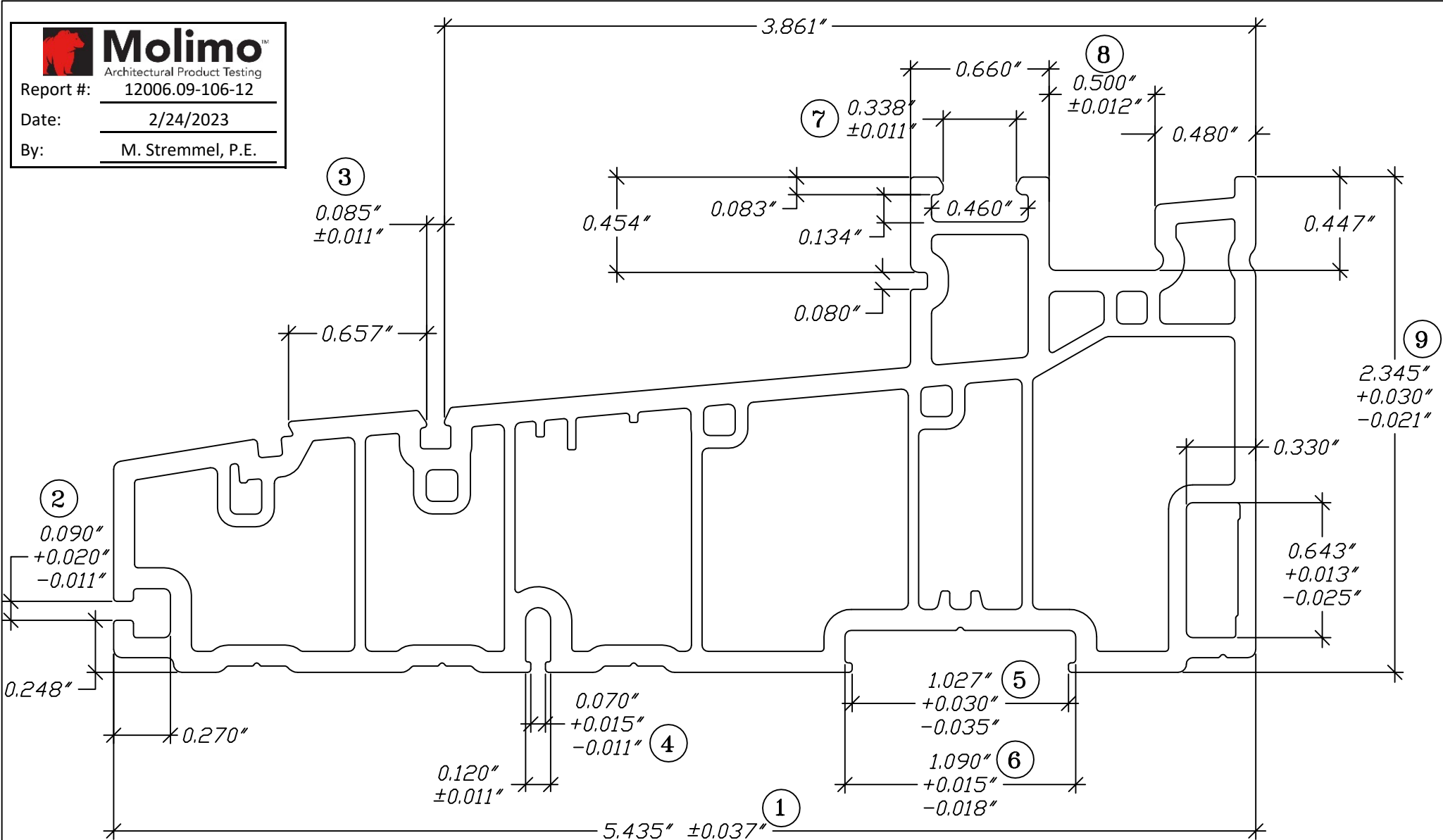

<p>RENSEIGNEMENTS FOURNIS A TITRE CONFIDENTIEL</p> <p>CE DOCUMENT EST PROTEGE PAR DES DROITS D'AUTEUR. A MOINS D'UNE AUTORISATION ECRITE, IL EST INTERDIT D'UTILISER, REPRODUIRE OU DIVULGUER SON CONTENU. D'AUTRE PART, CES RENSEIGNEMENTS PEUVENT ETRE PROTEGES PAR DES SECRETS DU METIER, DES BREVETS CANADIENS OU ETRANGERS, DES ENREGISTREMENT OU DES DEMANDES EN CE SENS. L'EMPLOI NON AUTORISE PEUT CONDUIRE A UNE VIOLATION. ON PEUT OBTENIR DES RENSEIGNEMENTS SUPPLEMENTAIRES EN EN Faisant LA DEMANDE PAR ECRIT.</p> <p>LE SEUL BUT DU PRESENT DOCUMENT EST DE FOURNIIR DES RENSEIGNEMENTS ET NE CONSTITUE PAS UNE OFFRE DE VENTE. LA LIVRAISON OU LA PRODUCTION DU CONTENU DE CE DESSIN, ANSI QUE DE CHANGER LES DONNEES TECHNIQUES SANS PREAVIS.</p> <p>L'USAGER DU PRESENT DOCUMENT RECONNAIT QUE P.H. TECH INC. ET SES REPRESENTANTS REJETTENT TOUTE RESPONSABILITE EN CAS DE DOMMAGE DECULANT DE QUELQUE FACON QUE CE SOIT, DE L'UTILISATION DE CES RENSEIGNEMENTS.</p>		<p>CONFIDENTIAL PROPRIETARY INFORMATION</p> <p>THIS DOCUMENT IS SUBJECT TO COPYRIGHT AND ANY USE, REPRODUCTION THEREOF OR DISCLOSURE TO OTHERS WITHOUT EXPRESS WRITTEN AUTHORIZATION IS PROHIBED. FURTHER, THIS CONFIDENTIAL PROPRIETARY INFORMATION MAY BE PROTECTED BY TRADE SECRETS, CANADIAN OR FOREIGN PATENTS, DESIGN REGISTRATIONS OR APPLICATION FOR SUCH. ANY UNAUTHORIZED USE MAY LEAD TO INFRINGEMENT. PARTICULARS ARE AVAILABLE ON WRITTEN REQUEST.</p> <p>THIS DOCUMENT IS SUPPLIED FOR INFORMATION PURPOSES ONLY AND IS NOT TO BE CONSTRUED AS AN OFFER FOR SALE. DUE TO POSSIBLE CHANGES AND IMPROVEMENTS IN DESIGN, P.H. TECH INC. RESERVES THE RIGHT TO MODIFY, CANCEL OR DISCONTINUE THE SALE, SUPPLY OR PRODUCTION OF THE CONTENTS OF THIS DRAWING OR ITS SPECIFICATIONS WITHOUT NOTICE.</p> <p>THE USER OF THIS DOCUMENT ACKNOWLEDGES THAT IN NO EVENT SHALL P.H. TECH INC. OR ITS AGENTS BE RESPONSIBLE TO THE PARTY RELYING ON THIS INFORMATION, FOR DAMAGES HOWEVER CAUSED.</p>		<p>⚠</p> <p>⚠</p> <p>⚠</p> <p>⚠</p> <p>⚠</p> <p>⚠</p> <p>⚠</p> <p>⚠</p> <p>REV.</p>	<p>DESCRIPTION</p>	<p>PAR/BY</p>	<p>DATE</p>	<p>DESSINE / DRAWN</p> <p>R.B.</p>	<p>DATE</p> <p>99/05/07</p>	<p>VERIFIE / VERIFIED</p>	<p>DATE</p>	<p>ECHELLE / SCALE</p> <p>1.5 = 1</p>	<p>MURS / WALLS</p>	<p>TOL. GENERALES</p> <p>S.P.I.</p>	<p>MATERIAU/MATERIAL</p>	<p>REF</p> <p>7000SPI</p> <p>SPI/</p>	<p>POIDS</p>	<p>POIDS MAXIMUM</p>	<p>TITRE / TITLE</p> <p>Seuil</p> <p>Sill</p>	<p>CODE</p> <p>SPI</p>	<p>7000</p>
---	--	--	--	---	--------------------	---------------	-------------	------------------------------------	-----------------------------	---------------------------	-------------	---------------------------------------	---------------------	-------------------------------------	--------------------------	---------------------------------------	--------------	----------------------	---	------------------------	-------------

**ph tech**™ P.H. Tech inc.  
8650 Boul. Guillaume-Couture  
Levis, Quebec Canada, G6V 9G9  
Tel.: (418) 833-3231 Fax: (418) 833-6847

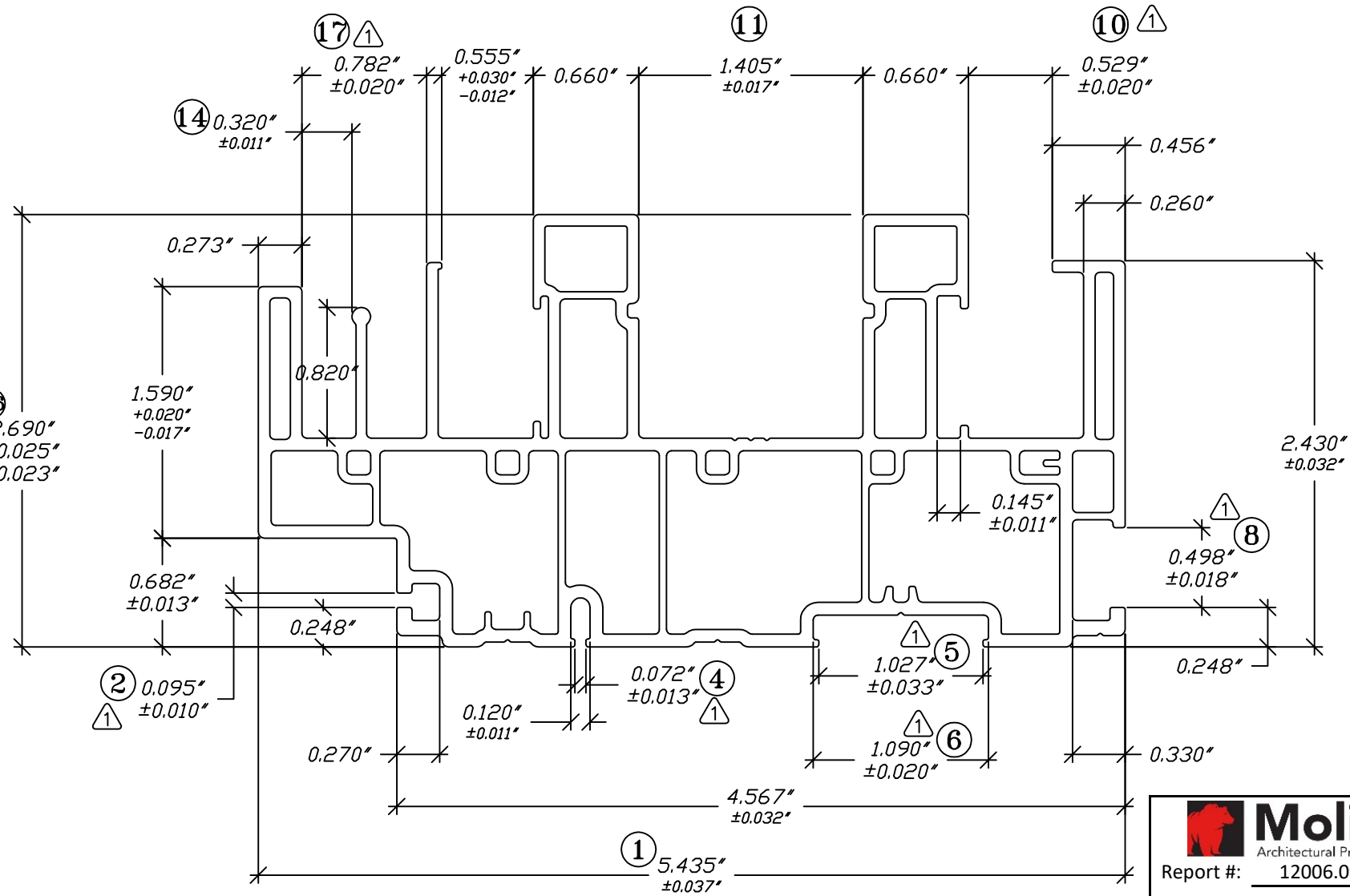



**Molimo™**  
Architectural Product Testing

Report #: 12006.09-106-12

Date: 2/24/2023

By: M. Stremmel, P.E.

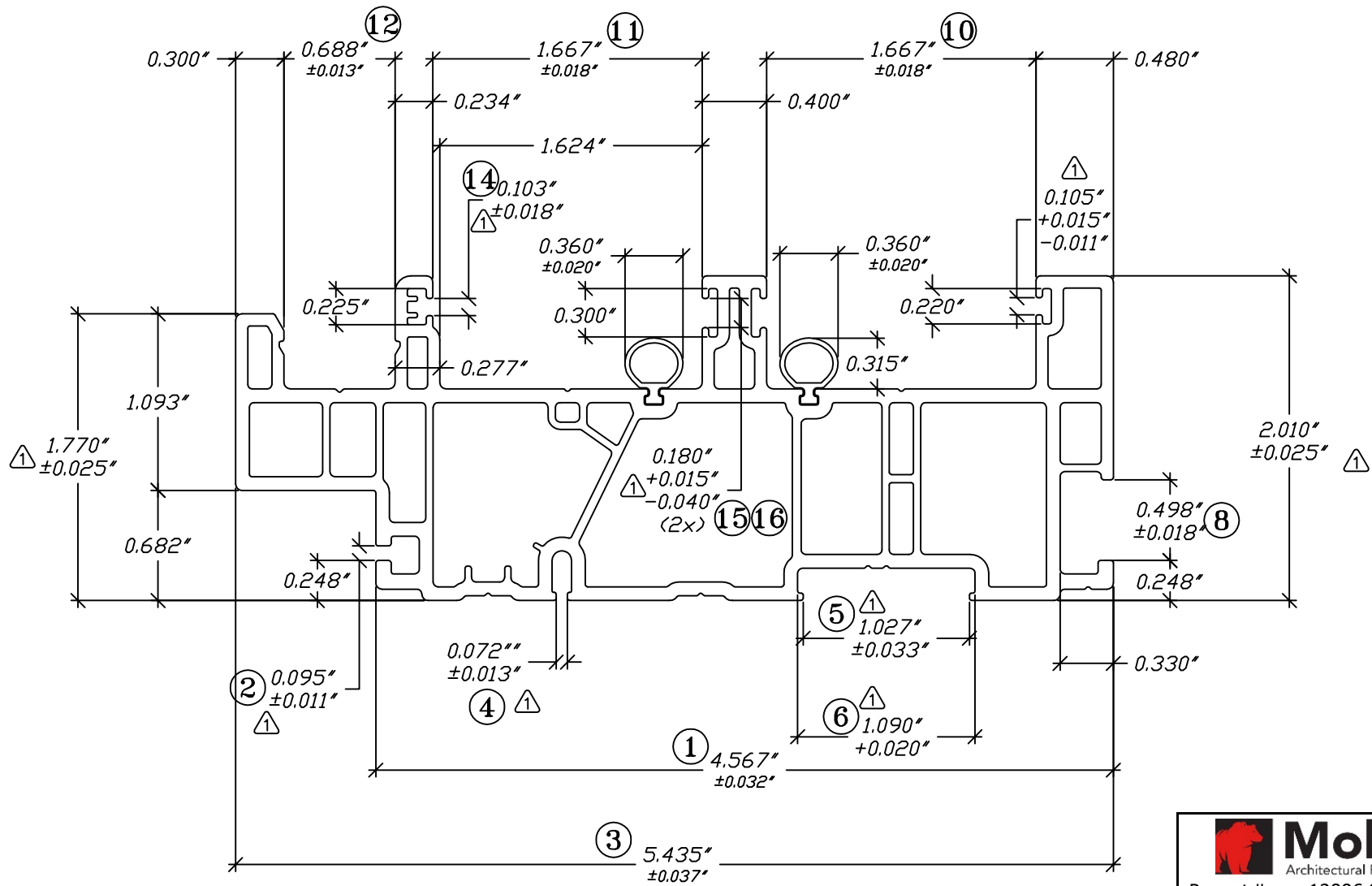
<p>RENSEIGNEMENTS FOURNIS A TITRE CONFIDENTIEL</p> <p>CE DOCUMENT EST PROTEGE PAR DES DROITS D'AUTEUR. A MOINS D'UNE AUTORISATION ECRITE, IL EST INTERDIT D'UTILISER, REPRODUIRE OU DIVULGUER SON CONTENU. D'AUTRE PART, CES RENSEIGNEMENTS PEUVENT ETRE PROTEGES PAR DES SECRETS DU METIER, DES BREVETS CANADIENS OU ETRANGERS, DES ENREGISTREMENT OU DES DEMANDES EN CE SENS. L'EMPLOI NON AUTORISE PEUT CONDUIRE A UNE VIOLATION. ON PEUT OBTENIR DES RENSEIGNEMENTS SUPPLEMENTAIRES EN FAISANT LA DEMANDE PAR ECRIT.</p> <p>LE SEUL BUT DU PRESENT DOCUMENT EST DE FOURNIER DES RENSEIGNEMENTS ET NE CONSTITUE PAS UNE OFFRE DE VENTE. LA LIVRAISON OU LA PRODUCTION DU CONTENU DE CE DESSIN, ANSI QUE DE CHANGER LES DONNEES TECHNIQUES SANS PREAVIS.</p> <p>L'USAGER DU PRESENT DOCUMENT RECONNAIT QUE P.H. TECH INC. ET SES REPRESENTANTS REJETTENT TOUTE RESPONSABILITE EN CAS DE DOMMAGE DECULANT DE QUELQUE FACON QUE CE SOIT, DE L'UTILISATION DE CES RENSEIGNEMENTS.</p>		<p>CONFIDENTIAL PROPRIETARY INFORMATION</p> <p>THIS DOCUMENT IS SUBJECT TO COPYRIGHT AND ANY USE, REPRODUCTION THEREOF OR DISCLOSURE TO OTHERS WITHOUT EXPRESS WRITTEN AUTHORIZATION IS PROHIBED. FURTHER, THIS CONFIDENTIAL PROPRIETARY INFORMATION MAY BE PROTECTED BY TRADE SECRETS, CANADIAN OR FOREIGN PATENTS, DESIGN REGISTRATIONS OR APPLICATION FOR SUCH. ANY UNAUTHORIZED USE MAY LEAD TO INFRINGEMENT. PARTICULARS ARE AVAILABLE ON WRITTEN REQUEST.</p> <p>THIS DOCUMENT IS SUPPLIED FOR INFORMATION PURPOSES ONLY AND IS NOT TO BE CONSTRUED AS AN OFFER FOR SALE. DUE TO POSSIBLE CHANGES AND IMPROVEMENTS IN DESIGN, P.H. TECH INC. RESERVES THE RIGHT TO MODIFY, CANCEL OR DISCONTINUE THE SALE, SUPPLY OR PRODUCTION OF THE CONTENTS OF THIS DRAWING OR ITS SPECIFICATIONS WITHOUT NOTICE.</p> <p>THE USER OF THIS DOCUMENT ACKNOWLEDGES THAT IN NO EVENT SHALL P.H. TECH INC. OR ITS AGENTS BE RESPONSIBLE TO THE PARTY RELYING ON THIS INFORMATION, FOR DAMAGES HOWEVER CAUSED.</p>		<p>DESSINE / DRAWN R.B.</p> <p>DATE 99/05/07</p>		<p>VERIFIE / VERIFIED</p> <p>DATE</p>		<p>TITRE / TITLE Tête Head</p>	
<p>17 ⚠</p> <p>0.782" ±0.020"</p> <p>0.555" +0.030" -0.012"</p> <p>0.660"</p> <p>1.405" ±0.017"</p> <p>0.660"</p> <p>0.529" ±0.020"</p> <p>0.320" ±0.011"</p> <p>0.273"</p> <p>0.820"</p> <p>2.690" +0.025" -0.023"</p> <p>1.590" +0.020" -0.017"</p> <p>0.248"</p> <p>0.682" ±0.013"</p> <p>0.248"</p> <p>0.095" ±0.010"</p> <p>0.120" ±0.011"</p> <p>0.072" ±0.013"</p> <p>1.027" ±0.033"</p> <p>0.145" ±0.011"</p> <p>0.498" ±0.018"</p> <p>0.248"</p> <p>1.090" ±0.020"</p> <p>0.330"</p> <p>4.567" ±0.032"</p> <p>0.270"</p> <p>5.435" ±0.037"</p> <p>2.430" ±0.032"</p>		<p>11</p> <p>10 ⚠</p> <p>2</p> <p>4</p> <p>5</p> <p>6</p> <p>8</p> <p>1</p>		<p>ECHELLE / SCALE 1 = 1</p> <p>MURS / WALLS</p> <p>TOL. GENERALES SPI</p>		<p>POIDS</p> <p>POIDS MAXIMUM</p>		<p>CODE SPI</p> <p>7002</p>	
<p>Z-16</p> <p>14</p>		<p>1</p> <p>2</p> <p>4</p> <p>5</p> <p>6</p> <p>8</p>		<p>Ajuster selon dessin PRO</p> <p>JFC</p> <p>09/02/27</p>		<p>MATERIAU/MATERIAL REF 7002SPI SPI/</p>		<p>REV.</p> <p>DESCRIPTION</p> <p>PAR/BY</p> <p>DATE</p>	





**Molimo™**  
Architectural Product Testing

Report #: 12006.09-106-12

Date: 2/24/2023

By: M. Stremmel, P.E.

RENSEIGNEMENTS FOURNIS A TITRE CONFIDENTIEL		CONFIDENTIAL PROPRIETARY INFORMATION		DESSINE / DRAWN		DATE		 P.H. Tech inc. 8650 Boul. Guillaume-Couture Levis, Quebec Canada, G6V 9G9 Tel.: (418) 833-3231 Fax: (418) 833-6847	
CE DOCUMENT EST PROTEGE PAR DES DROITS D'AUTEUR. A MOINS D'UNE AUTORISATION ECRITE, IL EST INTERDIT D'UTILISER, REPRODUIRE OU DIVULGUER SON CONTENU. D'AUTRE PART, CES RENSEIGNEMENTS PEUVENT ETRE PROTEGES PAR DES SECRETS DU METIER, DES BREVETS CANADIENS OU ETRANGERS, DES ENREGISTREMENT OU DES DEMANDES EN CE SENS. L'EMPLOI NON AUTORISE PEUT CONDUIRE A UNE VIOLATION. ON PEUT OBTENIR DES RENSEIGNEMENTS SUPPLEMENTAIRES EN FAISANT LA DEMANDE PAR ECRIE.		THIS DOCUMENT IS SUBJECT TO COPYRIGHT AND ANY USE, REPRODUCTION THEREOF OR DISCLOSURE TO OTHERS WITHOUT EXPRESS WRITTEN AUTHORIZATION IS PROHIBITED. FURTHER, THIS CONFIDENTIAL PROPRIETARY INFORMATION MAY BE PROTECTED BY TRADE SECRETS, CANADIAN OR FOREIGN PATENTS, DESIGN REGISTRATIONS OR APPLICATION FOR SUCH. ANY UNAUTHORIZED USE MAY LEAD TO INFRINGEMENT. PARTICULARS ARE AVAILABLE ON WRITTEN REQUEST.		R.B.		99/05/07			
LE SEUL BUT DU PRESENT DOCUMENT EST DE FOURNIER DES RENSEIGNEMENTS ET NE CONSTITUE PAS UNE OFFRE DE VENTE. LA LIVRAISON OU LA PRODUCTION DU CONTENU DE CE DESSIN, ANSI QUE DE CHANGER LES DONNEES TECHNIQUES SANS PREAVIS.		THIS DOCUMENT IS SUPPLIED FOR INFORMATION PURPOSES ONLY AND IS NOT TO BE CONSTRUED AS AN OFFER FOR SALE. DUE TO POSSIBLE CHANGES AND IMPROVEMENTS IN DESIGN, P.H. TECH INC. RESERVES THE RIGHT TO MODIFY, CANCEL OR DISCONTINUE THE SALE, SUPPLY OR PRODUCTION OF THE CONTENTS OF THIS DRAWING OR ITS SPECIFICATIONS WITHOUT NOTICE.		VERIFIE / VERIFIED		DATE		TITRE / TITLE	
L'USAGER DU PRESENT DOCUMENT RECONNAIT QUE P.H. TECH INC. ET SES REPRESENTANTS REJETTENT TOUTE RESPONSABILITE EN CAS DE DOMMAGE DECULANT DE QUELQUE FACON QUE CE SOIT, DE L'UTILATION DE CES RENSEIGNEMENTS.		THE USER OF THIS DOCUMENT ACKNOWLEDGES THAT IN NO EVENT SHALL P.H. TECH INC. OR ITS AGENTS BE RESPONSIBLE TO THE PARTY RELYING ON THIS INFORMATION, FOR DAMAGES HOWEVER CAUSED.		1 = 1		SPI		Jambage Jamb	
Ajuster selon dessin Pro		JFC 13/08/05		MATERIAU/MATERIAL		POIDS		CODE	
REV. DESCRIPTION		PAR/BY DATE		REF 7004SPI SPI/		POIDS MAXIMUM		SPI 7004	



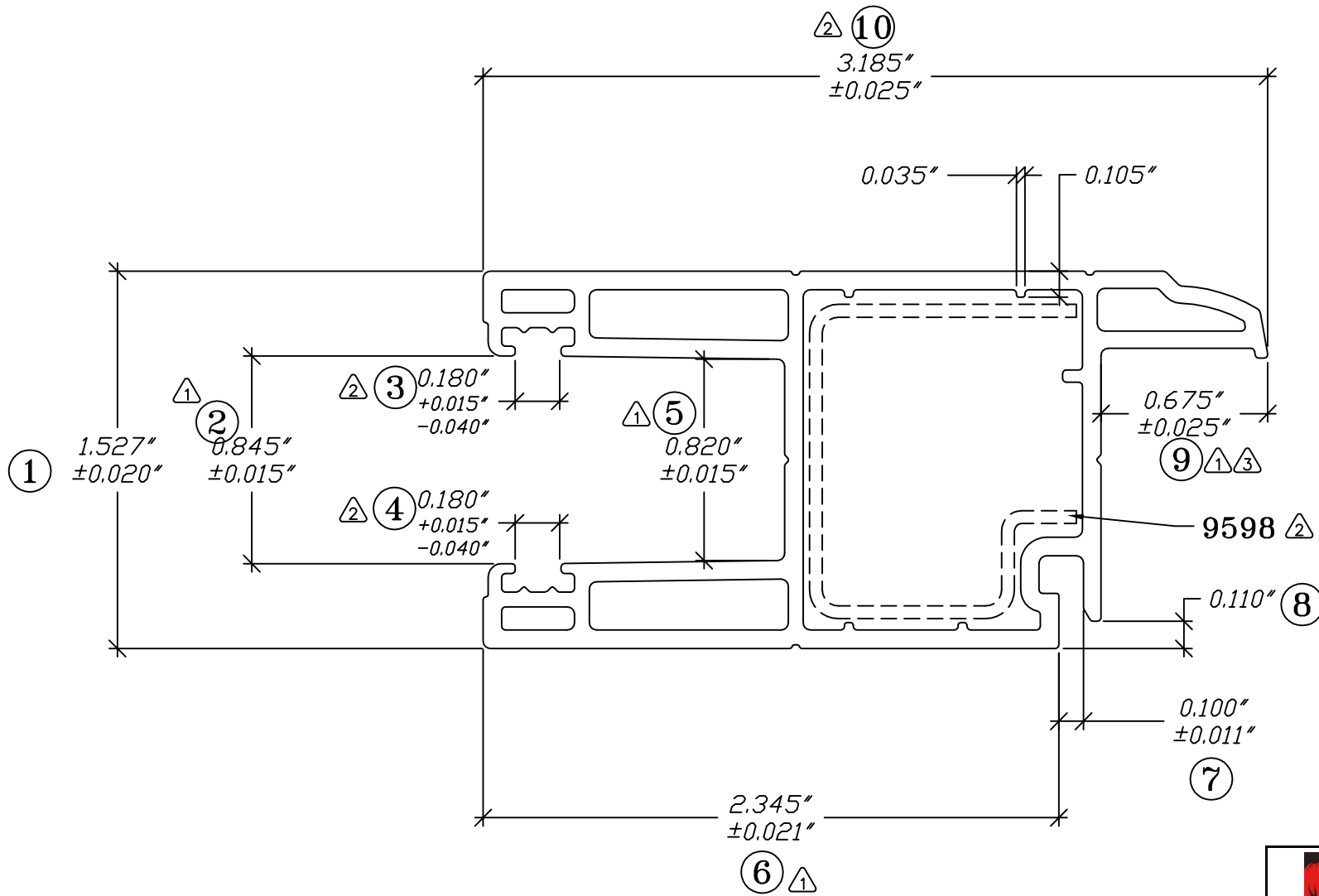

**Molimo™**  
Architectural Product Testing



Report #: 12006.09-106-12

Date: 2/24/2023

By: M. Stremmel, P.E.

<p>RENSEIGNEMENTS FOURNIS A TITRE CONFIDENTIEL</p> <p>CE DOCUMENT EST PROTEGE PAR DES DROITS D'AUTEUR. A MOINS D'UNE AUTORISATION ECRITE, IL EST INTERDIT D'UTILISER, REPRODUIRE OU DIVULGUER SON CONTENU. D'AUTRE PART, CES RENSEIGNEMENTS PEUVENT ETRE PROTEGES PAR DES SECRETS DU METIER, DES BREVETS CANADIENS OU ETRANGERS, DES ENREGISTREMENTS OU DES DEMANDES EN CE SENS. L'EMPLOI NON AUTORISE PEUT CONDUIRE A UNE VIOLATION. ON PEUT OBTENIR DES RENSEIGNEMENTS SUPPLEMENTAIRES EN EN FAISANT LA DEMANDE PAR ECRIT.</p> <p>LE SEUL BUT DU PRESENT DOCUMENT EST DE FOURNIER DES RENSEIGNEMENTS ET NE CONSTITUE PAS UNE OFFRE DE VENTE. LA LIVRAISON OU LA PRODUCTION DU CONTENU DE CE DESSIN, AINSI QUE DE CHANGER LES DONNEES TECHNIQUES SANS PREAVIS.</p> <p>L'USAGER DU PRESENT DOCUMENT RECONNAIT QUE P.H. TECH INC. ET SES REPRESENTANTS REJETENT TOUTE RESPONSABILITE EN CAS DE DOMMAGE DECULQUANT DE QUELQUE FACON QUE CE SOIT, DE L'UTILISATION DE CES RENSEIGNEMENTS.</p>		<p>CONFIDENTIAL PROPRIETARY INFORMATION</p> <p>THIS DOCUMENT IS SUBJECT TO COPYRIGHT AND ANY USE, REPRODUCTION THEREOF OR DISCLOSURE TO OTHERS WITHOUT EXPRESS WRITTEN AUTHORIZATION IS PROHIBITED. FURTHER, THIS CONFIDENTIAL PROPRIETARY INFORMATION MAY BE PROTECTED BY TRADE SECRETS, CANADIAN OR FOREIGN PATENTS, DESIGN REGISTRATIONS OR APPLICATION FOR SUCH. ANY UNAUTHORIZED USE MAY LEAD TO INFRINGEMENT. PARTICULARS ARE AVAILABLE ON WRITTEN REQUEST.</p> <p>THIS DOCUMENT IS SUPPLIED FOR INFORMATION PURPOSES ONLY AND IS NOT TO BE CONSTRUED AS AN OFFER FOR SALE. DUE TO POSSIBLE CHANGES AND IMPROVEMENTS IN DESIGN, P.H. TECH INC. RESERVES THE RIGHT TO MODIFY, CANCEL OR DISCONTINUE THE SALE, SUPPLY OR PRODUCTION OF THE CONTENTS OF THIS DRAWING OR ITS SPECIFICATIONS WITHOUT NOTICE.</p> <p>THE USER OF THIS DOCUMENT ACKNOWLEDGES THAT IN NO EVENT SHALL P.H. TECH INC. OR ITS AGENTS BE RESPONSIBLE TO THE PARTY RELYING ON THIS INFORMATION, FOR DAMAGES HOWEVER CAUSED.</p>		<p>DESSINE / DRAWN A-M Desrosiers</p> <p>DATE 06/03/17</p>	<p>VERIFIE / VERIFIED</p> <p>DATE</p>	<p>TITRE / TITLE Vol. soudé parclose ext./ Out. bead welded sash</p>					
<p>①</p>	<p>②</p>	<p>③</p>	<p>④</p>	<p>⑤</p>	<p>⑥</p>	<p>⑦</p>	<p>⑧</p>	<p>⑨</p>	<p>⑩</p>	<p>9598</p>	<p>7587</p>
<p>①</p>	<p>②</p>	<p>③</p>	<p>④</p>	<p>⑤</p>	<p>⑥</p>	<p>⑦</p>	<p>⑧</p>	<p>⑨</p>	<p>⑩</p>	<p>9598</p>	<p>7587</p>
<p>①</p>	<p>②</p>	<p>③</p>	<p>④</p>	<p>⑤</p>	<p>⑥</p>	<p>⑦</p>	<p>⑧</p>	<p>⑨</p>	<p>⑩</p>	<p>9598</p>	<p>7587</p>
<p>①</p>	<p>②</p>	<p>③</p>	<p>④</p>	<p>⑤</p>	<p>⑥</p>	<p>⑦</p>	<p>⑧</p>	<p>⑨</p>	<p>⑩</p>	<p>9598</p>	<p>7587</p>
<p>①</p>	<p>②</p>	<p>③</p>	<p>④</p>	<p>⑤</p>	<p>⑥</p>	<p>⑦</p>	<p>⑧</p>	<p>⑨</p>	<p>⑩</p>	<p>9598</p>	<p>7587</p>
<p>①</p>	<p>②</p>	<p>③</p>	<p>④</p>	<p>⑤</p>	<p>⑥</p>	<p>⑦</p>	<p>⑧</p>	<p>⑨</p>	<p>⑩</p>	<p>9598</p>	<p>7587</p>
<p>①</p>	<p>②</p>	<p>③</p>	<p>④</p>	<p>⑤</p>	<p>⑥</p>	<p>⑦</p>	<p>⑧</p>	<p>⑨</p>	<p>⑩</p>	<p>9598</p>	<p>7587</p>
<p>①</p>	<p>②</p>	<p>③</p>	<p>④</p>	<p>⑤</p>	<p>⑥</p>	<p>⑦</p>	<p>⑧</p>	<p>⑨</p>	<p>⑩</p>	<p>9598</p>	<p>7587</p>
<p>①</p>	<p>②</p>	<p>③</p>	<p>④</p>	<p>⑤</p>	<p>⑥</p>	<p>⑦</p>	<p>⑧</p>	<p>⑨</p>	<p>⑩</p>	<p>9598</p>	<p>7587</p>
<p>①</p>	<p>②</p>	<p>③</p>	<p>④</p>	<p>⑤</p>	<p>⑥</p>	<p>⑦</p>	<p>⑧</p>	<p>⑨</p>	<p>⑩</p>	<p>9598</p>	<p>7587</p>
<p>①</p>	<p>②</p>	<p>③</p>	<p>④</p>	<p>⑤</p>	<p>⑥</p>	<p>⑦</p>	<p>⑧</p>	<p>⑨</p>	<p>⑩</p>	<p>9598</p>	<p>7587</p>
<p>①</p>	<p>②</p>	<p>③</p>	<p>④</p>	<p>⑤</p>	<p>⑥</p>	<p>⑦</p>	<p>⑧</p>	<p>⑨</p>	<p>⑩</p>	<p>9598</p>	<p>7587</p>
<p>①</p>	<p>②</p>	<p>③</p>	<p>④</p>	<p>⑤</p>	<p>⑥</p>	<p>⑦</p>	<p>⑧</p>	<p>⑨</p>	<p>⑩</p>	<p>9598</p>	<p>7587</p>
<p>①</p>	<p>②</p>	<p>③</p>	<p>④</p>	<p>⑤</p>	<p>⑥</p>	<p>⑦</p>	<p>⑧</p>	<p>⑨</p>	<p>⑩</p>	<p>9598</p>	<p>7587</p>
<p>①</p>	<p>②</p>	<p>③</p>	<p>④</p>	<p>⑤</p>	<p>⑥</p>	<p>⑦</p>	<p>⑧</p>	<p>⑨</p>	<p>⑩</p>	<p>9598</p>	<p>7587</p>
<p>①</p>	<p>②</p>	<p>③</p>	<p>④</p>	<p>⑤</p>	<p>⑥</p>	<p>⑦</p>	<p>⑧</p>	<p>⑨</p>	<p>⑩</p>	<p>9598</p>	<p>7587</p>
<p>①</p>	<p>②</p>	<p>③</p>	<p>④</p>	<p>⑤</p>	<p>⑥</p>	<p>⑦</p>	<p>⑧</p>	<p>⑨</p>	<p>⑩</p>	<p>9598</p>	<p>7587</p>
<p>①</p>	<p>②</p>	<p>③</p>	<p>④</p>	<p>⑤</p>	<p>⑥</p>	<p>⑦</p>	<p>⑧</p>	<p>⑨</p>	<p>⑩</p>	<p>9598</p>	<p>7587</p>
<p>①</p>	<p>②</p>	<p>③</p>	<p>④</p>	<p>⑤</p>	<p>⑥</p>	<p>⑦</p>	<p>⑧</p>	<p>⑨</p>	<p>⑩</p>	<p>9598</p>	<p>7587</p>
<p>①</p>	<p>②</p>	<p>③</p>	<p>④</p>	<p>⑤</p>	<p>⑥</p>	<p>⑦</p>	<p>⑧</p>	<p>⑨</p>	<p>⑩</p>	<p>9598</p>	<p>7587</p>
<p>①</p>	<p>②</p>	<p>③</p>	<p>④</p>	<p>⑤</p>	<p>⑥</p>	<p>⑦</p>	<p>⑧</p>	<p>⑨</p>	<p>⑩</p>	<p>9598</p>	<p>7587</p>
<p>①</p>	<p>②</p>	<p>③</p>	<p>④</p>	<p>⑤</p>	<p>⑥</p>	<p>⑦</p>	<p>⑧</p>	<p>⑨</p>	<p>⑩</p>	<p>9598</p>	<p>7587</p>
<p>①</p>	<p>②</p>	<p>③</p>	<p>④</p>	<p>⑤</p>	<p>⑥</p>	<p>⑦</p>	<p>⑧</p>	<p>⑨</p>	<p>⑩</p>	<p>9598</p>	<p>7587</p>
<p>①</p>	<p>②</p>	<p>③</p>	<p>④</p>	<p>⑤</p>	<p>⑥</p>	<p>⑦</p>	<p>⑧</p>	<p>⑨</p>	<p>⑩</p>	<p>9598</p>	<p>7587</p>
<p>①</p>	<p>②</p>	<p>③</p>	<p>④</p>	<p>⑤</p>	<p>⑥</p>	<p>⑦</p>	<p>⑧</p>	<p>⑨</p>	<p>⑩</p>	<p>9598</p>	<p>7587</p>
<p>①</p>	<p>②</p>	<p>③</p>	<p>④</p>	<p>⑤</p>	<p>⑥</p>	<p>⑦</p>	<p>⑧</p>	<p>⑨</p>	<p>⑩</p>	<p>9598</p>	<p>7587</p>
<p>①</p>	<p>②</p>	<p>③</p>	<p>④</p>	<p>⑤</p>	<p>⑥</p>	<p>⑦</p>	<p>⑧</p>	<p>⑨</p>	<p>⑩</p>	<p>9598</p>	<p>7587</p>
<p>①</p>	<p>②</p>	<p>③</p>	<p>④</p>	<p>⑤</p>	<p>⑥</p>	<p>⑦</p>	<p>⑧</p>	<p>⑨</p>	<p>⑩</p>	<p>9598</p>	<p>7587</p>
<p>①</p>	<p>②</p>	<p>③</p>	<p>④</p>	<p>⑤</p>	<p>⑥</p>	<p>⑦</p>	<p>⑧</p>	<p>⑨</p>	<p>⑩</p>	<p>9598</p>	<p>7587</p>
<p>①</p>	<p>②</p>	<p>③</p>	<p>④</p>	<p>⑤</p>	<p>⑥</p>	<p>⑦</p>	<p>⑧</p>	<p>⑨</p>	<p>⑩</p>	<p>9598</p>	<p>7587</p>
<p>①</p>	<p>②</p>	<p>③</p>	<p>④</p>	<p>⑤</p>	<p>⑥</p>	<p>⑦</p>	<p>⑧</p>	<p>⑨</p>	<p>⑩</p>	<p>9598</p>	<p>7587</p>
<p>①</p>	<p>②</p>	<p>③</p>	<p>④</p>	<p>⑤</p>	<p>⑥</p>	<p>⑦</p>	<p>⑧</p>	<p>⑨</p>	<p>⑩</p>	<p>9598</p>	<p>7587</p>
<p>①</p>	<p>②</p>	<p>③</p>	<p>④</p>	<p>⑤</p>	<p>⑥</p>	<p>⑦</p>	<p>⑧</p>	<p>⑨</p>	<p>⑩</p>	<p>9598</p>	<p>7587</p>
<p>①</p>	<p>②</p>	<p>③</p>	<p>④</p>	<p>⑤</p>	<p>⑥</p>	<p>⑦</p>	<p>⑧</p>	<p>⑨</p>	<p>⑩</p>	<p>9598</p>	<p>7587</p>
<p>①</p>	<p>②</p>	<p>③</p>	<p>④</p>	<p>⑤</p>	<p>⑥</p>	<p>⑦</p>	<p>⑧</p>	<p>⑨</p>	<p>⑩</p>	<p>9598</p>	<p>7587</p>
<p>①</p>	<p>②</p>	<p>③</p>	<p>④</p>	<p>⑤</p>	<p>⑥</p>	<p>⑦</p>	<p>⑧</p>	<p>⑨</p>	<p>⑩</p>	<p>9598</p>	<p>7587</p>
<p>①</p>	<p>②</p>	<p>③</p>	<p>④</p>	<p>⑤</p>	<p>⑥</p>	<p>⑦</p>	<p>⑧</p>	<p>⑨</p>	<p>⑩</p>	<p>9598</p>	<p>7587</p>
<p>①</p>	<p>②</p>	<p>③</p>	<p>④</p>	<p>⑤</p>	<p>⑥</p>	<p>⑦</p>	<p>⑧</p>	<p>⑨</p>	<p>⑩</p>	<p>9598</p>	<p>7587</p>
<p>①</p>	<p>②</p>	<p>③</p>	<p>④</p>	<p>⑤</p>	<p>⑥</p>	<p>⑦</p>	<p>⑧</p>	<p>⑨</p>	<p>⑩</p>	<p>9598</p>	<p>7587</p>
<p>①</p>	<p>②</p>	<p>③</p>	<p>④</p>	<p>⑤</p>	<p>⑥</p>	<p>⑦</p>	<p>⑧</p>	<p>⑨</p>	<p>⑩</p>	<p>9598</p>	<p>7587</p>
<p>①</p>	<p>②</p>	<p>③</p>	<p>④</p>	<p>⑤</p>	<p>⑥</p>	<p>⑦</p>	<p>⑧</p>	<p>⑨</p>	<p>⑩</p>	<p>9598</p>	<p>7587</p>
<p>①</p>	<p>②</p>	<p>③</p>	<p>④</p>	<p>⑤</p>	<p>⑥</p>	<p>⑦</p>	<p>⑧</p>	<p>⑨</p>	<p>⑩</p>	<p>9598</p>	<p>7587</p>
<p>①</p>	<p>②</p>	<p>③</p>	<p>④</p>	<p>⑤</p>	<p>⑥</p>	<p>⑦</p>	<p>⑧</p>	<p>⑨</p>	<p>⑩</p>	<p>9598</p>	<p>7587</p>
<p>①</p>	<p>②</p>	<p>③</p>	<p>④</p>	<p>⑤</p>	<p>⑥</p>	<p>⑦</p>	<p>⑧</p>	<p>⑨</p>	<p>⑩</p>	<p>9598</p>	<p>7587</p>
<p>①</p>	<p>②</p>	<p>③</p>	<p>④</p>	<p>⑤</p>	<p>⑥</p>	<p>⑦</p>	<p>⑧</p>	<p>⑨</p>	<p>⑩</p>	<p>9598</p>	<p>7587</p>
<p>①</p>	<p>②</p>	<p>③</p>	<p>④</p>	<p>⑤</p>	<p>⑥</p>	<p>⑦</p>	<p>⑧</p>	<p>⑨</p>	<p>⑩</p>	<p>9598</p>	<p>7587</p>
<p>①</p>	<p>②</p>	<p>③</p>	<p>④</p>	<p>⑤</p>	<p>⑥</p>	<p>⑦</p>	<p>⑧</p>	<p>⑨</p>	<p>⑩</p>	<p>9598</p>	<p>7587</p>
<p>①</p>	<p>②</p>	<p>③</p>	<p>④</p>	<p>⑤</p>	<p>⑥</p>	<p>⑦</p>	<p>⑧</p>	<p>⑨</p>	<p>⑩</p>	<p>9598</p>	<p>7587</p>
<p>①</p>	<p>②</p>	<p>③</p>	<p>④</p>	<p>⑤</p>	<p>⑥</p>	<p>⑦</p>	<p>⑧</p>	<p>⑨</p>	<p>⑩</p>	<p>9598</p>	<p>7587</p>
<p>①</p>	<p>②</p>	<p>③</p>	<p>④</p>	<p>⑤</p>	<p>⑥</p>	<p>⑦</p>	<p>⑧</p>	<p>⑨</p>	<p>⑩</p>	<p>9598</p>	<p>7587</p>
<p>①</p>	<p>②</p>	<p>③</p>	<p>④</p>	<p>⑤</p>	<p>⑥</p>	<p>⑦</p>	<p>⑧</p>	<p>⑨</p>	<p>⑩</p>	<p>9598</p>	<p>7587</p>
<p>①</p>	<p>②</p>	<p>③</p>	<p>④</p>	<p>⑤</p>	<p>⑥</p>	<p>⑦</p>	<p>⑧</p>	<p>⑨</p>	<p>⑩</p>	<p>9598</p>	<p>7587</p>
<p>①</p>	<p>②</p>	<p>③</p>	<p>④</p>	<p>⑤</p>	<p>⑥</p>	<p>⑦</p>	<p>⑧</p>	<p>⑨</p>	<p>⑩</p>	<p>9598</p>	<p>7587</p>
<p>①</p>	<p>②</p>	<p>③</p>	<p>④</p>	<p>⑤</p>	<p>⑥</p>	<p>⑦</p>	<p>⑧</p>	<p>⑨</p>	<p>⑩</p>	<p>9598</p>	<p>7587</p>
<p>①</p>	<p>②</p>	<p>③</p>	<p>④</p>	<p>⑤</p>	<p>⑥</p>	<p>⑦</p>	<p>⑧</p>	<p>⑨</p>	<p>⑩</p>	<p>9598</p>	<p>7587</p>
<p>①</p>	<p>②</p>	<p>③</p>	<p>④</p>	<p>⑤</p>	<p>⑥</p>	<p>⑦</p>	<p>⑧</p>	<p>⑨</p>	<p>⑩</p>	<p>9598</p>	<p>7587</p>
<p>①</p>	<p>②</p>	<p>③</p>	<p>④</p>	<p>⑤</p>	<p>⑥</p>	<p>⑦</p>	<p>⑧</p>	<p>⑨</p>	<p>⑩</p>	<p>9598</p>	<p>7587</p>
<p>①</p>	<p>②</p>	<p>③</p>	<p>④</p>	<p>⑤</p>	<p>⑥</p>	<p>⑦</p>	<p>⑧</p>	<p>⑨</p>	<p>⑩</p>	<p>9598</p>	<p>7587</p>
<p>①</p>	<p>②</p>	<p>③</p>	<p>④</p>	<p>⑤</p>	<p>⑥</p>	<p>⑦</p>	<p>⑧</p>	<p>⑨</p>	<p>⑩</p>	<p>9598</p>	<p>7587</p>
<p>①</p>	<p>②&lt;/</p>										

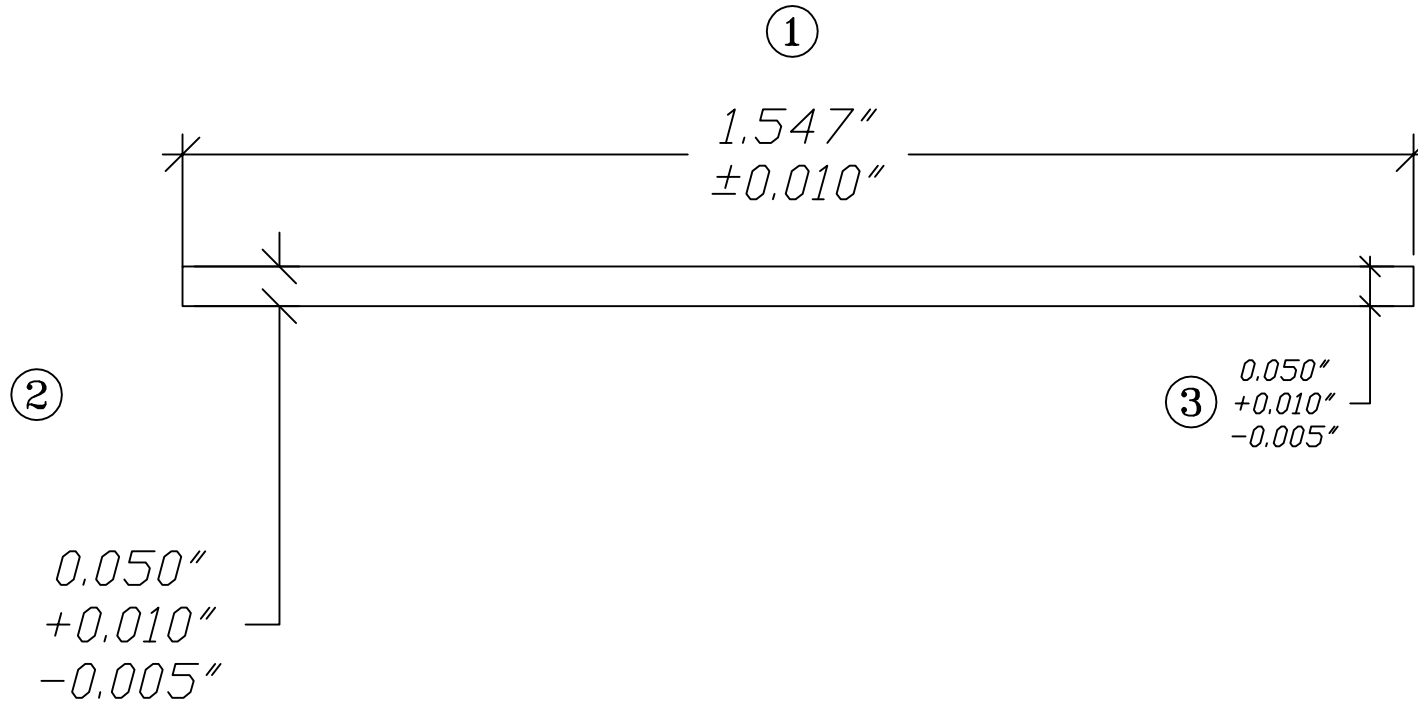

**Molimo™**  
Architectural Product Testing

Report #: 12006.09-106-12

Date: 2/24/2023

By: M. Stremmel, P.E.

RENSEIGNEMENTS FOURNIS A TITRE CONFIDENTIEL

CE DOCUMENT EST PROTEGE PAR DES DROITS D'AUTEUR. A MOINS D'UNE AUTORISATION ECRITE, IL EST INTERDIT D'UTILISER, REPRODUIRE OU DIVULGUER SON CONTENU. D'AUTRE PART, CES RENSEIGNEMENTS PEUVENT ETRE PROTEGES PAR DES SECRETS DU METIER, DES BREVETS CANADIENS OU ETRANGERS, DES ENREGISTREMENT OU DES DEMANDES EN CE SENS. L'EMPLOI NON AUTORISE PEUT CONDUIRE A UNE VIOLATION. ON PEUT OBTENIR DES RENSEIGNEMENTS SUPPLEMENTAIRES EN FAISANT LA DEMANDE PAR ECRIT.

LE SEUL BUT DU PRESENT DOCUMENT EST DE FOURNIER DES RENSEIGNEMENTS ET NE CONSTITUE PAS UNE OFFRE DE VENTE. LA LIVRAISON OU LA PRODUCTION DU CONTENU DE CE DESSIN, ANSI QUE DE CHANGER LES DONNEES TECHNIQUES SANS PREAVIS.

L'USAGER DU PRESENT DOCUMENT RECONNAIT QUE P.H. TECH INC. ET SES REPRESENTANTS REJETENT TOUTE RESPONSABILITE EN CAS DE DOMMAGE DECULQUANT DE QUELQUE FACON QUE CE SOIT, DE L'UTILISATION DE CES RENSEIGNEMENTS.

CONFIDENTIAL PROPRIETARY INFORMATION

THIS DOCUMENT IS SUBJECT TO COPYRIGHT AND ANY USE, REPRODUCTION THEREOF OR DISCLOSURE TO OTHERS WITHOUT EXPRESS WRITTEN AUTHORIZATION IS PROHIBED. FURTHER, THIS CONFIDENTIAL PROPRIETARY INFORMATION MAY BE PROTECTED BY TRADE SECRETS, CANADIAN OR FOREIGN PATENTS, DESIGN REGISTRATIONS OR APPLICATION FOR SUCH. ANY UNAUTHORIZED USE MAY LEAD TO INFRINGEMENT. PARTICULARS ARE AVAILABLE ON WRITTEN REQUEST.

THIS DOCUMENT IS SUPPLIED FOR INFORMATION PURPOSES ONLY AND IS NOT TO BE CONSTRUED AS AN OFFER FOR SALE. DUE TO POSSIBLE CHANGES AND IMPROVEMENTS IN DESIGN, P.H. TECH INC. RESERVES THE RIGHT TO MODIFY, CANCEL OR DISCONTINUE THE SALE, SUPPLY OR PRODUCTION OF THE CONTENTS OF THIS DRAWING OR ITS SPECIFICATIONS WITHOUT NOTICE.

THE USER OF THIS DOCUMENT ACKNOWLEDGES THAT IN NO EVENT SHALL P.H. TECH INC. OR ITS AGENTS BE RESPONSIBLE TO THE PARTY RELYING ON THIS INFORMATION, FOR DAMAGES HOWEVER CAUSED.

⚠			
⚠			
⚠			
⚠			
⚠			
⚠			
⚠			
⚠			
REV.	DESCRIPTION	PAR/BY	DATE

DESSINE / DRAWN		DATE
François St-Amand		2013/06/21
VERIFIE / VERIFIED		DATE
ECHELLE / SCALE	MURS / WALLS	TOL. GENERALES
4=1		S.P.I
MATERIAU/MATERIAL	REF	POIDS
	8723SPI	
	SPI/	

		P.H. Tech inc. 8650 Boul. Guillaume-Couture Lévis, Quebec Canada, G6V 9G9		Tel.: (418) 833-3231 Fax: (418) 833-6847
		TITRE / TITLE ache-poussière de seuil Porte impact		
POIDS MAXIMUM	CODE SPI	8723		

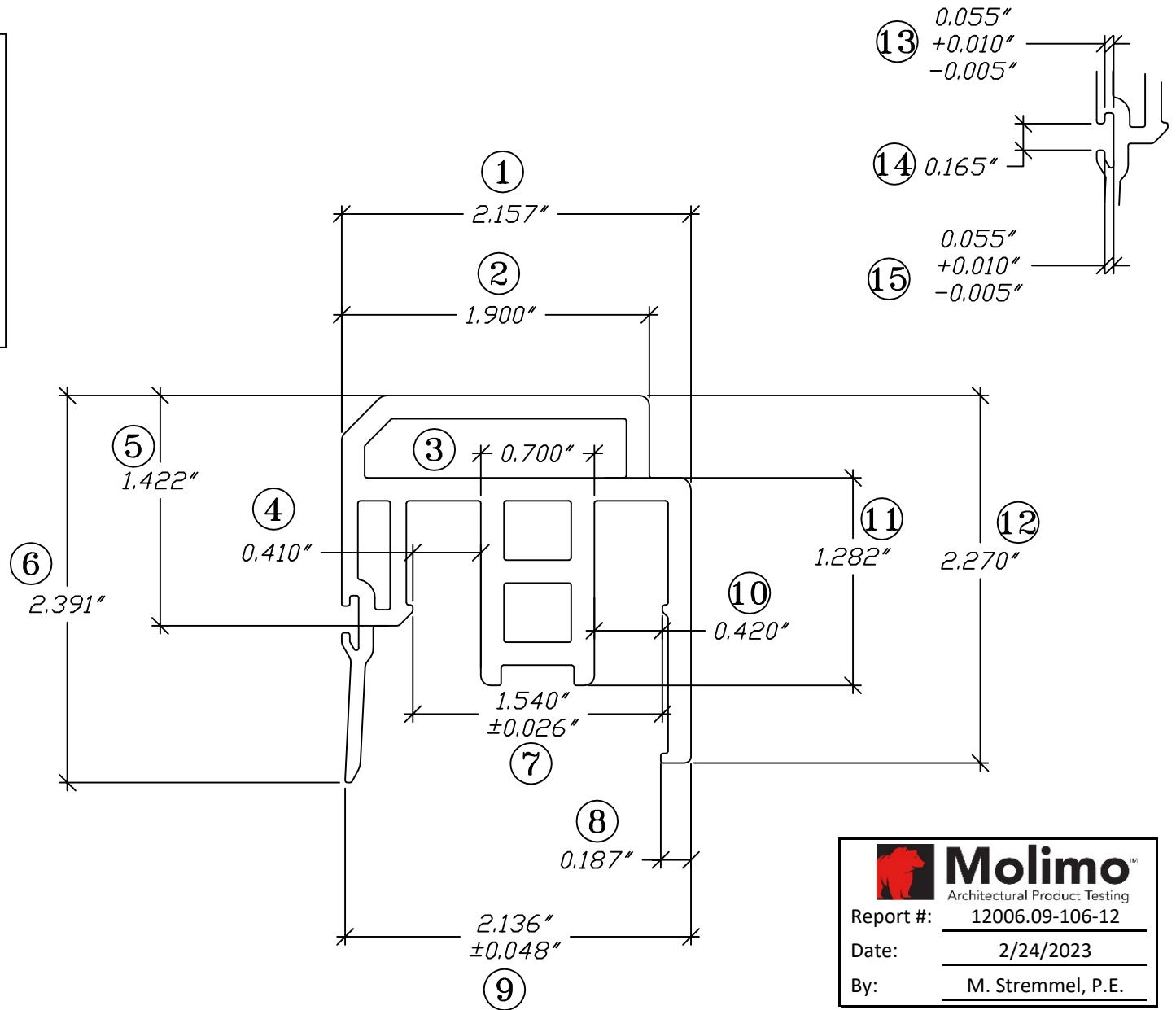
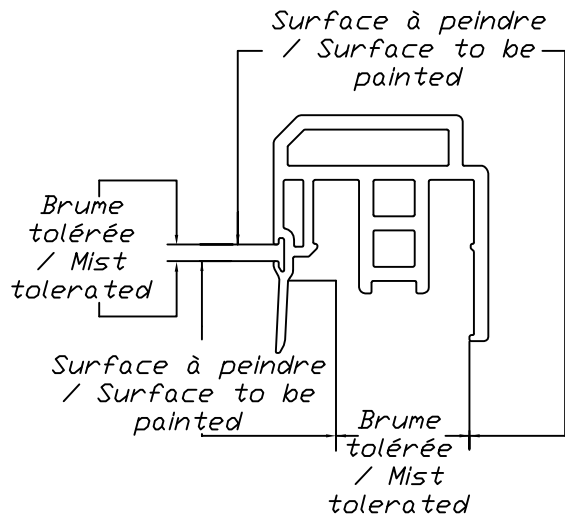

**Molimo™**  
Architectural Product Testing

Report #: 12006.09-106-12

Date: 2/24/2023

By: M. Stremmel, P.E.

RENSEIGNEMENTS FOURNIS A TITRE CONFIDENTIEL		CONFIDENTIAL PROPRIETARY INFORMATION		DESSINE / DRAWN		DATE		P.H. Tech inc. 8650 Boul. Guillaume-Couture Lévis, Québec Canada, G6V 9G9 Tel.: (418) 833-3231 Fax: (418) 833-6847	
CE DOCUMENT EST PROTÉGÉ PAR DES DROITS D'AUTEUR. A MOINS D'UNE AUTORISATION ÉCRITE, IL EST INTERDIT D'UTILISER, REPRODUIRE OU DIVULGUER SON CONTENU. D'AUTRE PART, CES RENSEIGNEMENTS PEUVENT ÊTRE PROTÉGÉS PAR DES SECRETS DU MÉTIER, DES BREVETS CANADIENS OU ÉTRANGERS, DES ENREGISTREMENTS OU DES DEMANDES EN CE SENS. L'EMPLOI NON AUTORISÉ PEUT CONDUIRE À UNE VIOLATION. ON PEUT OBTENIR DES RENSEIGNEMENTS SUPPLÉMENTAIRES EN FAISANT LA DEMANDE PAR ÉCRIT.		THIS DOCUMENT IS SUBJECT TO COPYRIGHT AND ANY USE, REPRODUCTION THEREOF OR DISCLOSURE TO OTHERS WITHOUT EXPRESS WRITTEN AUTHORIZATION IS PROHIBITED. FURTHER, THIS CONFIDENTIAL PROPRIETARY INFORMATION MAY BE PROTECTED BY TRADE SECRETS, CANADIAN OR FOREIGN PATENTS, DESIGN REGISTRATIONS OR APPLICATION FOR SUCH. ANY UNAUTHORIZED USE MAY LEAD TO INFRINGEMENT. PARTICULARS ARE AVAILABLE ON WRITTEN REQUEST.		J.-F. Chainey		11/05/10			
LE SEUL BUT DU PRÉSENT DOCUMENT EST DE FOURNIR DES RENSEIGNEMENTS ET NE CONSTITUE PAS UNE OFFRE DE VENTE. LA LIVRAISON OU LA PRODUCTION DU CONTENU DE CE DESSIN, ANSI QU'É DE CHANGER LES DONNÉES TECHNIQUES SANS PRÉAVIS.		THIS DOCUMENT IS SUPPLIED FOR INFORMATION PURPOSES ONLY AND IS NOT TO BE CONSTRUED AS AN OFFER FOR SALE. DUE TO POSSIBLE CHANGES AND IMPROVEMENTS IN DESIGN, P.H. TECH INC. RESERVES THE RIGHT TO MODIFY, CANCEL OR DISCONTINUE THE SALE, SUPPLY OR PRODUCTION OF THE CONTENTS OF THIS DRAWING OR ITS SPECIFICATIONS WITHOUT NOTICE.		VERIFIE / VERIFIED		DATE		TITRE / TITLE	
L'USAGER DU PRÉSENT DOCUMENT RECONNAÎT QUE P.H. TECH INC. ET SES REPRÉSENTANTS REJETTENT TOUTE RESPONSABILITÉ EN CAS DE DOMMAGE DÉCOULANT DE QUELQUE FAÇON QUE CE SOIT, DE L'UTILISATION DE CES RENSEIGNEMENTS.		THE USER OF THIS DOCUMENT ACKNOWLEDGES THAT IN NO EVENT SHALL P.H. TECH INC. OR ITS AGENTS BE RESPONSIBLE TO THE PARTY RELYING ON THIS INFORMATION, FOR DAMAGES HOWEVER CAUSED.		1 = 1		±0.015"		Rail de rencontre Interlock	
REV.		DESCRIPTION		MATERIAU/MATERIAL		POIDS		POIDS MAXIMUM	
				REF 8936spi SPI/				CODE SPI	
				DATE				8936	

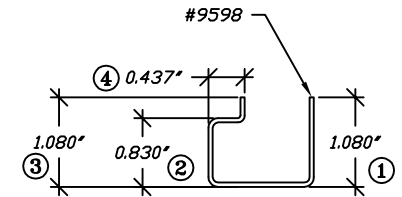
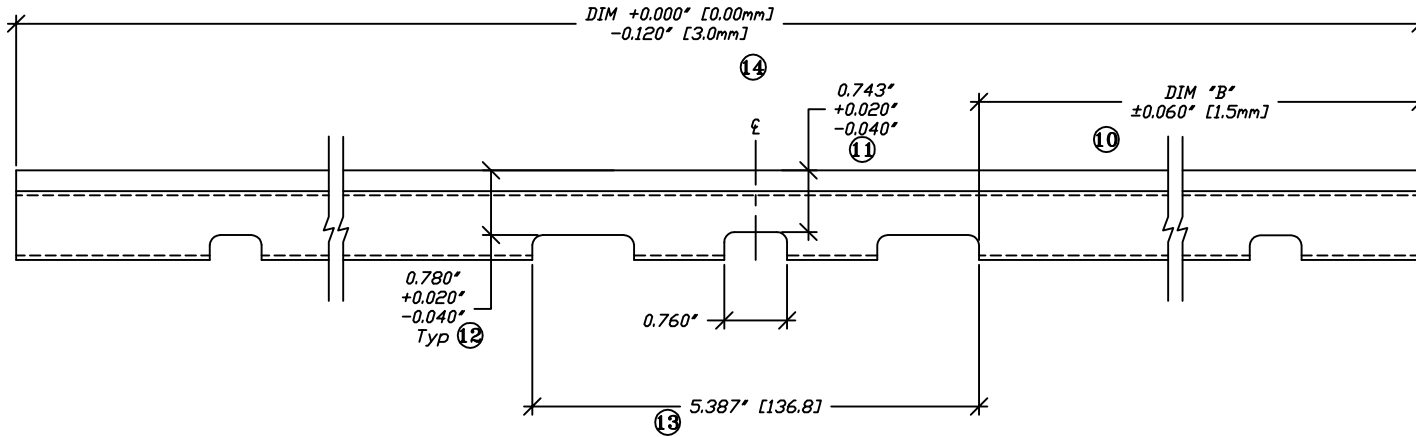
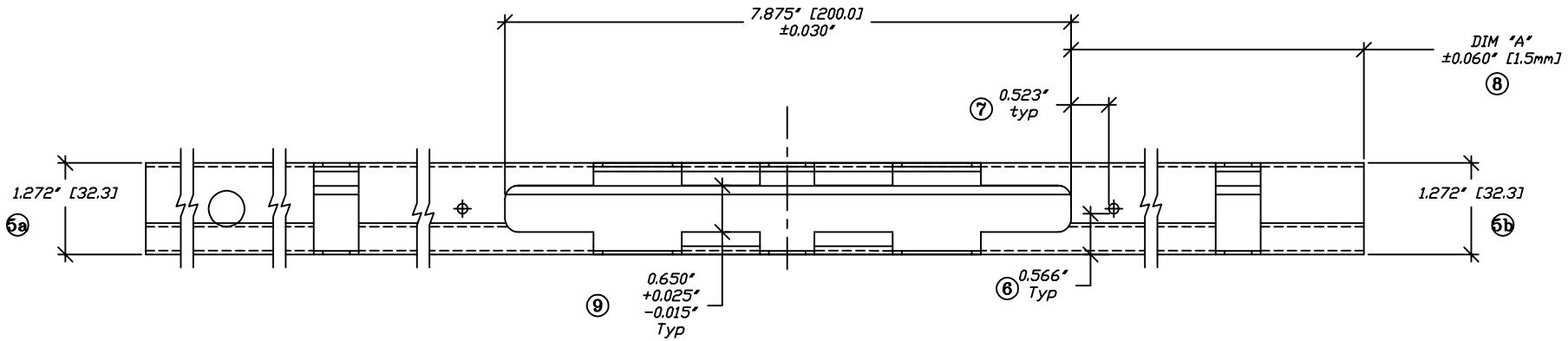

**Molimo**<sup>TM</sup>  
Architectural Product Testing

Report #: 12006.09-106-12

Date: 2/24/2023

By: M. Stremmel, P.E.

RENSEIGNEMENTS FOURNIS A TITRE CONFIDENTIEL

CE DOCUMENT EST PROTEGE PAR DES DROITS D'AUTEUR. A MOINS D'UNE AUTORISATION ECRITE, IL EST INTERDIT D'UTILISER, REPRODUIRE OU DIVULGUER SON CONTENU. D'AUTRE PART, CES RENSEIGNEMENTS PEUVENT ETRE PROTEGES PAR DES SECRETS DU METIER, DES BREVETS CANADIENS OU ETRANGERS, DES ENREGISTREMENTS OU DES DEMANDES EN CE SENS. L'EMPLOI NON AUTORISE PEUT CONDUIRE A UNE VIOLATION. ON PEUT OBTENIR DES RENSEIGNEMENTS SUPPLEMENTAIRES EN FAISANT LA DEMANDE PAR ECRIT.

LE SEUL BUT DU PRESENT DOCUMENT EST DE FOURNIER DES RENSEIGNEMENTS ET NE CONSTITUE PAS UNE OFFRE DE VENTE. LA LIVRAISON OU LA PRODUCTION DU CONTENU DE CE DESSIN, AINSI QUE DE CHANGER LES DONNEES TECHNIQUES SANS PREAVIS.

L'USAGER DU PRESENT DOCUMENT RECONNAIT QUE P.H. TECH INC. ET SES REPRESENTANTS REJETTENT TOUTE RESPONSABILITE EN CAS DE DOMMAGE DECULQUANT DE QUELQUE FACON QUE CE SOIT, DE L'UTILISATION DE CES RENSEIGNEMENTS.

CONFIDENTIAL PROPRIETARY INFORMATION

THIS DOCUMENT IS SUBJECT TO COPYRIGHT AND ANY USE, REPRODUCTION THEREOF OR DISCLOSURE TO OTHERS WITHOUT EXPRESS WRITTEN AUTHORIZATION IS PROHIBITED. FURTHER, THIS CONFIDENTIAL PROPRIETARY INFORMATION MAY BE PROTECTED BY TRADE SECRETS, CANADIAN OR FOREIGN PATENTS, DESIGN REGISTRATIONS OR APPLICATION FOR SUCH. ANY UNAUTHORIZED USE MAY LEAD TO INFRINGEMENT. PARTICULARS ARE AVAILABLE ON WRITTEN REQUEST.

THIS DOCUMENT IS SUPPLIED FOR INFORMATION PURPOSES ONLY AND IS NOT TO BE CONSTRUED AS AN OFFER FOR SALE. DUE TO POSSIBLE CHANGES AND IMPROVEMENTS IN DESIGN, P.H. TECH INC. RESERVES THE RIGHT TO MODIFY, CANCEL OR DISCONTINUE THE SALE, SUPPLY OR PRODUCTION OF THE CONTENTS OF THIS DRAWING OR ITS SPECIFICATIONS WITHOUT NOTICE.

THE USER OF THIS DOCUMENT ACKNOWLEDGES THAT IN NO EVENT SHALL P.H. TECH INC. OR ITS AGENTS BE RESPONSIBLE TO THE PARTY RELYING ON THIS INFORMATION, FOR DAMAGES HOWEVER CAUSED.

△			
⑥			
⑤			
④			
③			
②			
①			
REV.	DESCRIPTION	PAR/BY	DATE

DESSINE / DRAWN		DATE
RCI		16/08/12
VERIFIE / VERIFIED		DATE
ECHELLE / SCALE	MURS / WALLS	TOL. GENERALES
1/2 = 1		±0.015"
MATERIAU/MATERIAL	REF	POIDS
	9598	
	PRO/	

<b>ph</b> <sup>TM</sup> <b>tech</b>		P.H. Tech inc. 8650 Boul. Guillaume-Couture Levis, Quebec Canada, G6V 9G9		Tel.: (418) 833-3231 Fax: (418) 833-6847	
TITRE / TITLE					
Renfort #9598 Reinforcement pour/for #7517 , #7587					
POIDS MAXIMUM	CODE	9598			
	PRO				

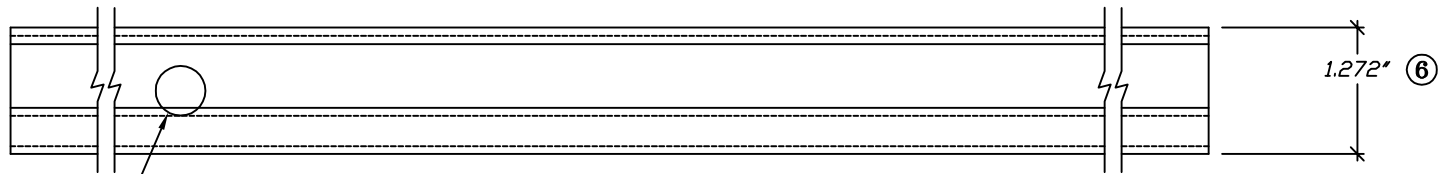

Note: Ce trou est requis pour la coupe par le fournisseur seulement.

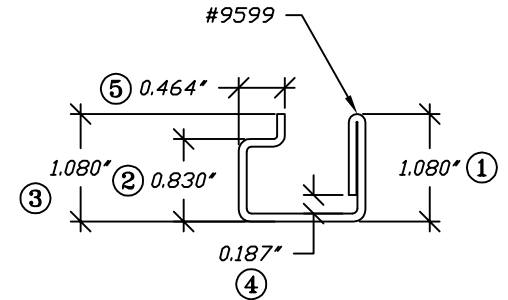
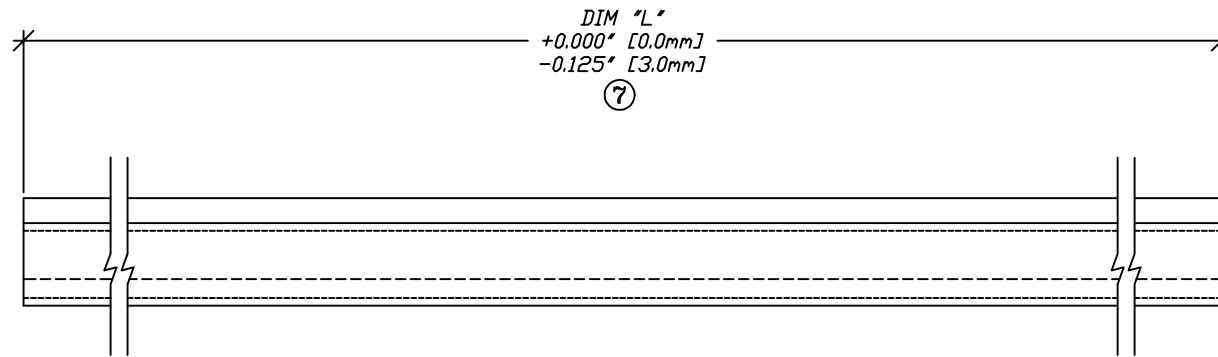

**LA PIECE FINIE DOIT :**

- 1-AVOIR LES COTES EGALLES ET PARALLELES
- 2-AVOIR DES ANGLES PRECIS A 90°
- 3-ETRE EXEMPT DE GONDOLAGE
- ⑧ 4-NE PAS AVOIR DE TORSION SUPERIEUR A 0.010"/Pi. LINEAIRE
- ⑨ 5-COURBURE MAXIMALE ACCEPTÉE: 0.078" [2mm] TOUTE DIRECTION

PORTE	HAUTEUR REELLE	DIM "L" <sup>+0.000" [0.00mm]</sup> <sub>-0.125" [3.0mm]</sub>
1800.0mm	70.866" [1800.0mm]	60.492" [1536.5mm] ⚠
2019.0mm	79.500" [2019.3mm]	69.125" [1755.8mm]
2080.0mm	81.874" [2079.6mm]	71.500" [1816.1mm] ⚠
2400.0mm	94.488" [2400.0mm]	84.113" [2136.5mm]

**Molimo™**  
Architectural Product Testing

Report #: 12006.09-106-12



Date: 2/24/2023

By: M. Stremmel, P.E.

RENSSEIGNEMENTS FOURNIS A TITRE CONFIDENTIEL	CONFIDENTIAL PROPRIETARY INFORMATION	DESSINE / DRAWN	DATE						
CE DOCUMENT EST PROTEGE PAR DES DROITS D'AUTEUR. A MOINS D'UNE AUTORISATION ECRITE, IL EST INTERDIT D'UTILISER, REPRODUIRE OU DIVULGUER SON CONTENU. D'AUTRE PART, CES RENSEIGNEMENTS PEUVENT ETRE PROTEGES PAR DES SECRETS DU METIER, DES BREVETS CANADIENS OU ETRANGERS, DES ENREGISTREMENTS OU DES DEMANDES EN CE SENS. L'EMPLOI NON AUTORISE PEUT CONDUIRE A UNE VIOLATION. ON PEUT OBTENIR DES RENSEIGNEMENTS SUPPLEMENTAIRES EN EN FAISANT LA DEMANDE PAR ECRIT.	THIS DOCUMENT IS SUBJECT TO COPYRIGHT AND ANY USE, REPRODUCTION THEREOF OR DISCLOSURE TO OTHERS WITHOUT EXPRESS WRITTEN AUTHORIZATION IS PROHIBED. FURTHER, THIS CONFIDENTIAL PROPRIETARY INFORMATION MAY BE PROTECTED BY TRADE SECRETS, CANADIAN OR FOREIGN PATENTS, DESIGN REGISTRATIONS OR APPLICATION FOR SUCH. ANY UNAUTHORIZED USE MAY LEAD TO INFRINGEMENT. PARTICULARS ARE AVAILABLE ON WRITTEN REQUEST.	R.B.	06/07/10						
LE SEUL BUT DU PRESENT DOCUMENT EST DE FOURNIER DES RENSEIGNEMENTS ET NE CONSTITUE PAS UNE OFFRE DE VENTE. LA LIVRAISON OU LA PRODUCTION DU CONTENU DE CE DESSIN, ANSI QUE DE CHANGER LES DONNEES TECHNIQUES SANS PREAVIS.	THIS DOCUMENT IS SUPPLIED FOR INFORMATION PURPOSES ONLY AND IS NOT TO BE CONSTRUED AS AN OFFER FOR SALE. DUE TO POSSIBLE CHANGES AND IMPROVEMENTS IN DESIGN, P.H. TECH INC. RESERVES THE RIGHT TO MODIFY, CANCEL OR DISCONTINUE THE SALE, SUPPLY OR PRODUCTION OF THE CONTENTS OF THIS DRAWING OR ITS SPECIFICATIONS WITHOUT NOTICE.	VERIFIE / VERIFIED	DATE	ECHELLE / SCALE		MURS / WALLS		TOL. GENERALES	
L'USAGER DU PRESENT DOCUMENT RECONNAIT QUE P.H. TECH INC. ET SES REPRESENTANTS REJETENT TOUTE RESPONSABILITE EN CAS DE DOMMAGE DECULANT DE QUELQUE FACON QUE CE SOIT, DE L'UTILISATION DE CES RENSEIGNEMENTS.	THE USER OF THIS DOCUMENT ACKNOWLEDGES THAT IN NO EVENT SHALL P.H. TECH INC. OR ITS AGENTS BE RESPONSIBLE TO THE PARTY RELYING ON THIS INFORMATION, FOR DAMAGES HOWEVER CAUSED.	1/2 = 1	±0.015"						
REV.	DESCRIPTION	PAR/BY	DATE	MATERIAU/MATERIAL	REF	POIDS	POIDS MAXIMUM	CODE	
⚠									
⚠									
⚠									
⚠									
⚠	Ajout trou de pilotage de 1/2 Ø	RCa	12/02/15						
⚠	Ajout renfort 1800	JFC	11/10/05						
⚠	Etail 69.125" [1816.1mm]	R.B.	07/11/12						
					REF				
					9599PRO				
					PRO/				
				TITRE / TITLE					
				RENFORT #9599 POUR					
				RAIL DE CENTRE #7506 et #7516					
				PRO	9599				

P.H. Tech inc.  
8650 Boul.  
Guillaume-Couture  
Levis, Quebec  
Canada, G6V 9G9

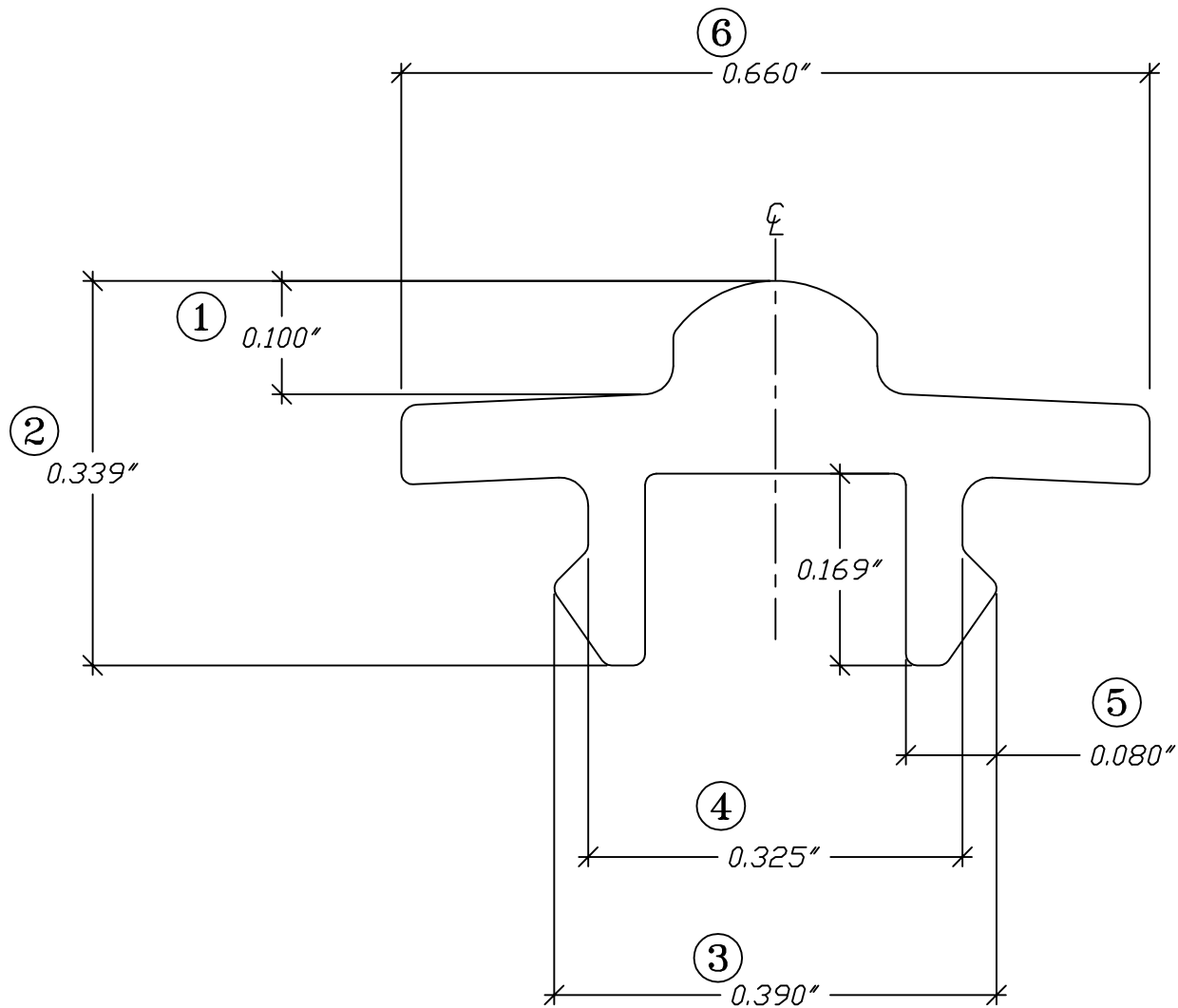
Tel.: (418) 833-3231  
Fax: (418) 833-6847

**Molimo™**  
Architectural Product Testing

Report #: 12006.09-106-12

Date: 2/24/2023

By: M. Stremmel, P.E.

RENSEIGNEMENTS FOURNIS A TITRE CONFIDENTIEL

CE DOCUMENT EST PROTÉGÉ PAR DES DROITS D'AUTEUR. À MOINS D'UNE AUTORISATION ÉCRITE, IL EST INTERDIT D'UTILISER, REPRODUIRE OU DIVULGUER SON CONTENU. D'AUTRE PART, CES RENSEIGNEMENTS PEUVENT ÊTRE PROTÉGÉS PAR DES SECRETS DU MÉTIER, DES BREVETS CANADIENS OU ÉTRANGERS, DES ENREGISTREMENTS OU DES DEMANDES EN CE SENS. L'EMPLOI NON AUTORISÉ PEUT CONDUIRE À UNE VIOLATION. ON PEUT OBTENIR DES RENSEIGNEMENTS SUPPLÉMENTAIRES EN FAISANT LA DEMANDE PAR ÉCRIT.

LE SEUL BUT DU PRÉSENT DOCUMENT EST DE FOURNIR DES RENSEIGNEMENTS ET NE CONSTITUE PAS UNE OFFRE DE VENTE. LA LIVRAISON OU LA PRODUCTION DU CONTENU DE CE DESSIN, ANSI QU'ÉCHÉC DE CHANGER LES DONNÉES TECHNIQUES SANS PRÉAVIS.

L'USAGER DU PRÉSENT DOCUMENT RECONNAÎT QUE P.H. TECH INC. ET SES REPRÉSENTANTS REJETTENT TOUTE RESPONSABILITÉ EN CAS DE DOMMAGE DÉCOULANT DE QUELQUE FAÇON QUE CE SOIT, DE L'UTILISATION DE CES RENSEIGNEMENTS.

CONFIDENTIAL PROPRIETARY INFORMATION

THIS DOCUMENT IS SUBJECT TO COPYRIGHT AND ANY USE, REPRODUCTION THEREOF OR DISCLOSURE TO OTHERS WITHOUT EXPRESS WRITTEN AUTHORIZATION IS PROHIBITED. FURTHER, THIS CONFIDENTIAL PROPRIETARY INFORMATION MAY BE PROTECTED BY TRADE SECRETS, CANADIAN OR FOREIGN PATENTS, DESIGN REGISTRATIONS OR APPLICATION FOR SUCH. ANY UNAUTHORIZED USE MAY LEAD TO INFRINGEMENT. PARTICULARS ARE AVAILABLE ON WRITTEN REQUEST.

THIS DOCUMENT IS SUPPLIED FOR INFORMATION PURPOSES ONLY AND IS NOT TO BE CONSTRUED AS AN OFFER FOR SALE. DUE TO POSSIBLE CHANGES AND IMPROVEMENTS IN DESIGN, P.H. TECH INC. RESERVES THE RIGHT TO MODIFY, CANCEL OR DISCONTINUE THE SALE, SUPPLY OR PRODUCTION OF THE CONTENTS OF THIS DRAWING OR ITS SPECIFICATIONS WITHOUT NOTICE.

THE USER OF THIS DOCUMENT ACKNOWLEDGES THAT IN NO EVENT SHALL P.H. TECH INC. OR ITS AGENTS BE RESPONSIBLE TO THE PARTY RELYING ON THIS INFORMATION, FOR DAMAGES HOWEVER CAUSED.

①			
②			
③			
④			
⑤			
⑥			
⑦			
⑧			
REV.	DESCRIPTION	PAR/BY	DATE

DESSINE / DRAWN		DATE
R.B.		99/09/08
VERIFIE / VERIFIED		DATE
ECHELLE / SCALE	MURS / WALLS	TOL. GENERALES
6 = 1		COMMERCIALES
MATERIAU/MATERIAL	REF	POIDS
ALUMINIUM	9790SPI	
	SPI/	

 P.H. Tech inc. 8650 Boul. Guillaume-Couture Levis, Quebec Canada, G6V 9G9 Tel.: (418) 833-3231 Fax: (418) 833-6847		TITRE / TITLE	
		RAIL DE ROULEMENT (S-700 et S-7000)	
POIDS MAXIMUM	CODE SPI	9790	

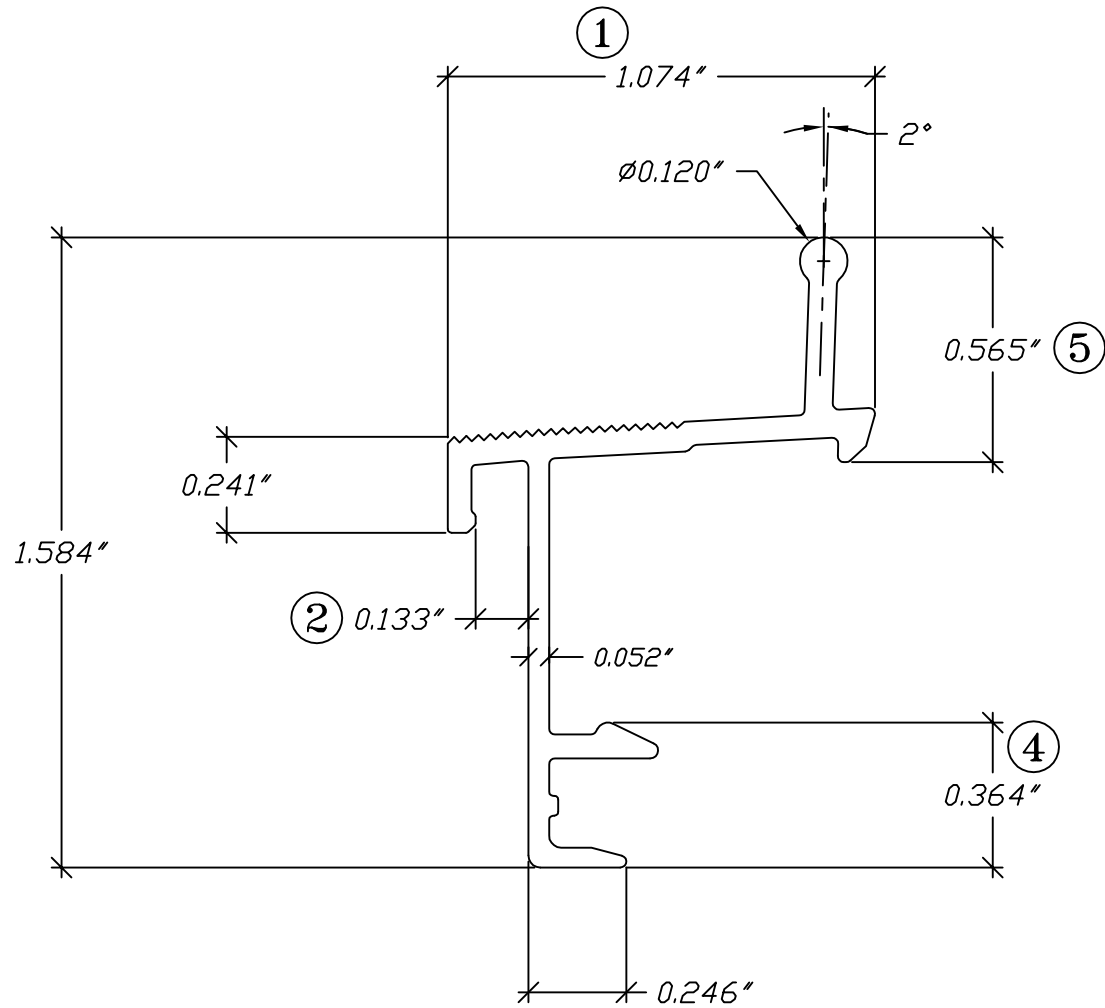

**Molimo™**  
Architectural Product Testing

Report #: 12006.09-106-12

Date: 2/24/2023

By: M. Stremmel, P.E.

<p>RENSEIGNEMENTS FOURNIS A TITRE CONFIDENTIEL</p> <p>CE DOCUMENT EST PROTEGE PAR DES DROITS D'AUTEUR. A MOINS D'UNE AUTORISATION ECRITE, IL EST INTERDIT D'UTILISER, REPRODUIRE OU DIVULGUER SON CONTENU. D'AUTRE PART, CES RENSEIGNEMENTS PEUVENT ETRE PROTEGES PAR DES SECRETS DU METIER, DES BREVETS CANADIENS OU ETRANGERS, DES ENREGISTREMENT OU DES DEMANDES EN CE SENS. L'EMPLOI NON AUTORISE PEUT CONDUIRE A UNE VIOLATION. ON PEUT OBTENIR DES RENSEIGNEMENTS SUPPLEMENTAIRES EN FAISANT LA DEMANDE PAR ECRIT.</p> <p>LE SEUL BUT DU PRESENT DOCUMENT EST DE FOURNIER DES RENSEIGNEMENTS ET NE CONSTITUE PAS UNE OFFRE DE VENTE. LA LIVRAISON OU LA PRODUCTION DU CONTENU DE CE DESSIN, ANSI QUE DE CHANGER LES DONNEES TECHNIQUES SANS PREAVIS.</p> <p>L'USAGER DU PRESENT DOCUMENT RECONNAIT QUE P.H. TECH INC. ET SES REPRESENTANTS REJETENT TOUTE RESPONSABILITE EN CAS DE DOMMAGE DECULQUANT DE QUELQUE FACON QUE CE SOIT, DE L'UTILISATION DE CES RENSEIGNEMENTS.</p>		<p>CONFIDENTIAL PROPRIETARY INFORMATION</p> <p>THIS DOCUMENT IS SUBJECT TO COPYRIGHT AND ANY USE, REPRODUCTION THEREOF OR DISCLOSURE TO OTHERS WITHOUT EXPRESS WRITTEN AUTHORIZATION IS PROHIBED. FURTHER, THIS CONFIDENTIAL PROPRIETARY INFORMATION MAY BE PROTECTED BY TRADE SECRETS, CANADIAN OR FOREIGN PATENTS, DESIGN REGISTRATIONS OR APPLICATION FOR SUCH. ANY UNAUTHORIZED USE MAY LEAD TO INFRINGEMENT. PARTICULARS ARE AVAILABLE ON WRITTEN REQUEST.</p> <p>THIS DOCUMENT IS SUPPLIED FOR INFORMATION PURPOSES ONLY AND IS NOT TO BE CONSTRUED AS AN OFFER FOR SALE. DUE TO POSSIBLE CHANGES AND IMPROVEMENTS IN DESIGN, P.H. TECH INC. RESERVES THE RIGHT TO MODIFY, CANCEL OR DISCONTINUE THE SALE, SUPPLY OR PRODUCTION OF THE CONTENTS OF THIS DRAWING OR ITS SPECIFICATIONS WITHOUT NOTICE.</p> <p>THE USER OF THIS DOCUMENT ACKNOWLEDGES THAT IN NO EVENT SHALL P.H. TECH INC. OR ITS AGENTS BE RESPONSIBLE TO THE PARTY RELYING ON THIS INFORMATION, FOR DAMAGES HOWEVER CAUSED.</p>		<p>⚠</p> <p>⚠</p> <p>⚠</p> <p>⚠</p> <p>⚠</p> <p>⚠</p> <p>⚠</p> <p>⚠</p>	<p>DESSINE / DRAWN</p> <p>Regis Cloutier</p> <p>DATE</p> <p>99/08/10</p> <p>VERIFIE / VERIFIED</p> <p>DATE</p> <p>ECHELLE / SCALE</p> <p>2 = 1</p> <p>MURS / WALLS</p> <p>TOL. GENERALES</p> <p>S.P.I.</p> <p>MATERIAU/MATERIAL</p> <p>REF 9991SPI SPI/</p> <p>POIDS</p> <p>POIDS MAXIMUM</p> <p>CODE SPI</p> <p>9991</p>	<p>TITRE / TITLE</p> <p>REVETEMENT EXTERIEUR DE SEUIL</p>
REV.	DESCRIPTION	PAR/BY	DATE			