



## Supplemental Instructions

### Pan Doors: Residential

 <b>CAUTION</b>	<p><b>Higher wind pressures and larger doors require additional reinforcement.</b></p> <p><b>Premature failure of door system may result from improper application.</b></p> <p><b>See chart in lower left corner of drawing sheet one for the approved wind pressures and door sizes.</b></p>
--	---

 <b>WARNING</b>	<p><b>These supplemental instructions do not contain basic door installation steps and related safety information.</b></p> <p><b>Failure to follow basic installation steps and related safety information may result in injury or death.</b></p> <p><b>Door installers must follow a primary instruction manual for basic door installation steps and related safety information.</b></p>
--	--

The correct selection of door and framing materials in adherence with local building code directives is the responsibility of the building owner/designer. Use of a reinforced garage door does not constitute automatic compliance with any building code. Local building code officials determine compliance criteria.

A locking system must be installed if the door is not electrically operated.

See drawing for stop molding requirements, when door is not more than 1" wider than opening. When using stop molding, secure molding with minimum 8d nails or 2-1/2" long screws.

Professional Engineer's seal provided only for verification of wind load construction details. Printed copies of this document are not considered signed and sealed and the signature must be verified on any electronic copies.

John E. Scates, P.E.  
 2560 King Arthur, Ste 124-54  
 Lewisville, Texas 75056  
 TXPE 56308, F-2203  
 Florida P.E. # 51737

**For Use With Drawing Number  
Z4-16-01308**

**Strut Placement**

Section Number	Door Height									
	6'-6" to 7'-0"	7'-6" to 8'-0"	8'-3" to 8'-9"	9'-0" to 10'-6"	10'-9" to 12'-3"	12'-6" to 14'-0"	14'-3" to 15'-9"	16'-0" to 17'-6"	17'-9" to 19'-3"	19'-6" to 20'-0"
12	N/A	N/A	N/A	N/A	N/A	N/A	N/A	N/A	N/A	1 at Detail A
11	N/A	N/A	N/A	N/A	N/A	N/A	N/A	N/A	1 at Detail A	1 at Detail B
10	N/A	N/A	N/A	N/A	N/A	N/A	N/A	1 at Detail A	1 at Detail B	1 at Detail B
9	N/A	N/A	N/A	N/A	N/A	N/A	1 at Detail A	1 at Detail B	1 at Detail B	1 at Detail B 1 at Detail C
8	N/A	N/A	N/A	N/A	N/A	1 at Detail A	1 at Detail B	1 at Detail B	1 at Detail B	1 at Detail B
7	N/A	N/A	N/A	N/A	1 at Detail A	1 at Detail B	1 at Detail B	1 at Detail B	1 at Detail B	1 at Detail B
6	N/A	N/A	N/A	1 at Detail A	1 at Detail B	1 at Detail B	1 at Detail B	1 at Detail B	1 at Detail B	1 at Detail B
5	N/A	1 at Detail A	1 at Detail A	1 at Detail B	1 at Detail B	1 at Detail B 1 at Detail C	1 at Detail B 1 at Detail C	1 at Detail B 1 at Detail C	1 at Detail B 1 at Detail C	1 at Detail B 1 at Detail C
4	1 at Detail A	1 at Detail B	1 at Detail B	1 at Detail B	1 at Detail B	1 at Detail B	1 at Detail B	1 at Detail B	1 at Detail B	1 at Detail B
3	1 at Detail B	1 at Detail B	1 at Detail B	1 at Detail B	1 at Detail B	1 at Detail B	1 at Detail B	1 at Detail B	1 at Detail B	1 at Detail B
2	1 at Detail B	1 at Detail B	1 at Detail B	1 at Detail B	1 at Detail B	1 at Detail B	1 at Detail B	1 at Detail B	1 at Detail B	1 at Detail B
1	1 at Detail B 1 at Detail C	1 at Detail B 1 at Detail C	1 at Detail B 1 at Detail C	1 at Detail B 1 at Detail C	1 at Detail B 1 at Detail C	1 at Detail B 1 at Detail C	1 at Detail B 1 at Detail C	1 at Detail B 1 at Detail C	1 at Detail B 1 at Detail C	1 at Detail B 1 at Detail C

**Push Nut Detail (use on all rollers)**

use 3/8" I. D. on bottom fixture roller stem  
use 7/16" I. D. on end hinge and top fixture roller stems

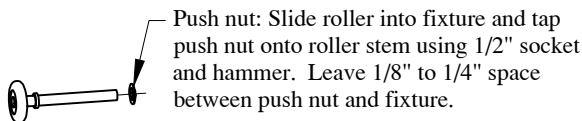

**Track Bracket Spacing**

Track bracket spacing shown for doors up to four sections high. Additional door sections may be added for maximum door height depicted on line drawing. Track brackets must be added (per track) for each section and spaced at a distance not greater than the corresponding section height (see line drawing for required quantities).

**Strut Placement Concerning Windows**

Where a strut crosses a window, it is acceptable to move the strut from a position of "Strut above hinge" down to "Strut on top half of the hinge".

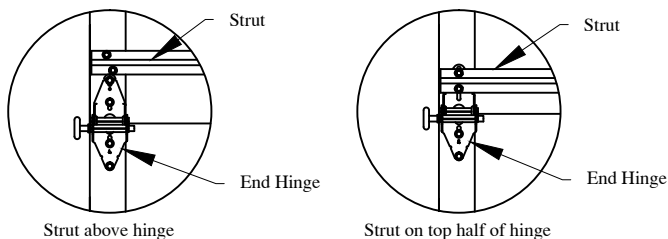

	Nominal Spacing
C	38"
B	28"
A	10"

+/-3" tolerance

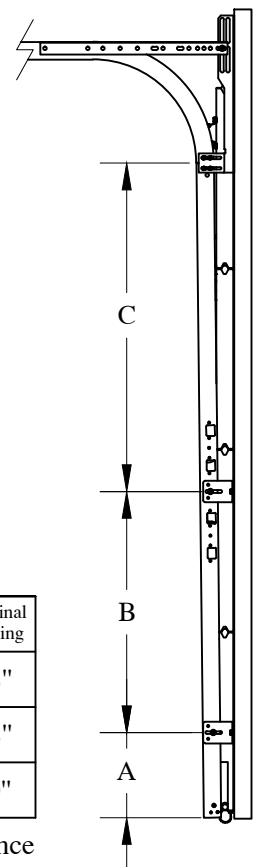

For Use With Drawing Number  
Z4-16-01308

**Strut Placement Detail**

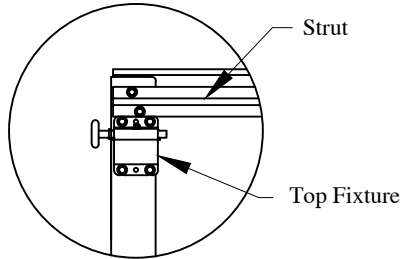

Strut above top fixture

**Detail A**

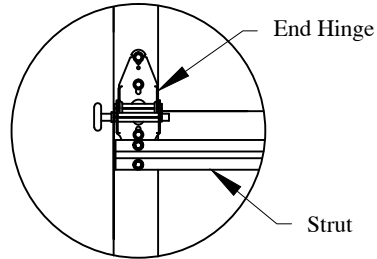

Strut on bottom half of hinge

**Detail B**

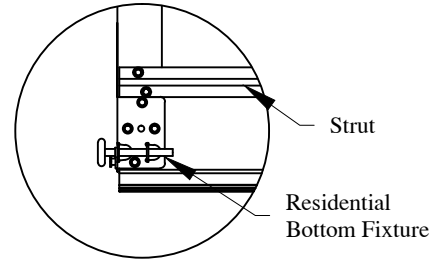

Strut above bottom fixture

**Detail C**

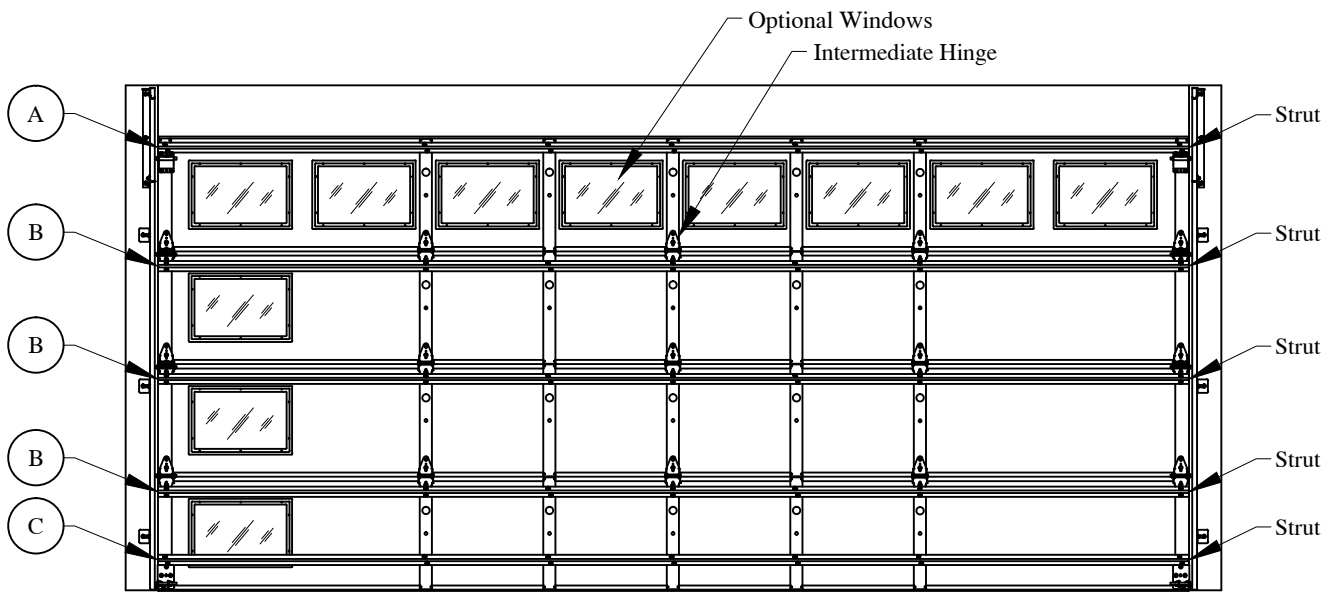

5 Struts

Glazing Options: (max daylight opening 39-3/8" x 12-1/2")  
 ◦ 1/8" Annealed DSB Glass  
 ◦ 1/4" Tempered Glass or Polycarbonate  
 ◦ 7/16" Insulated Glass comprised of  
 Two Annealed DSB Glass or  
 Two Tempered DSB Glass

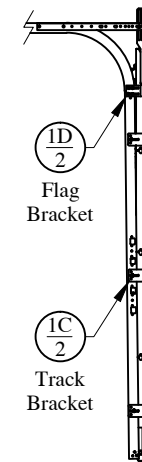
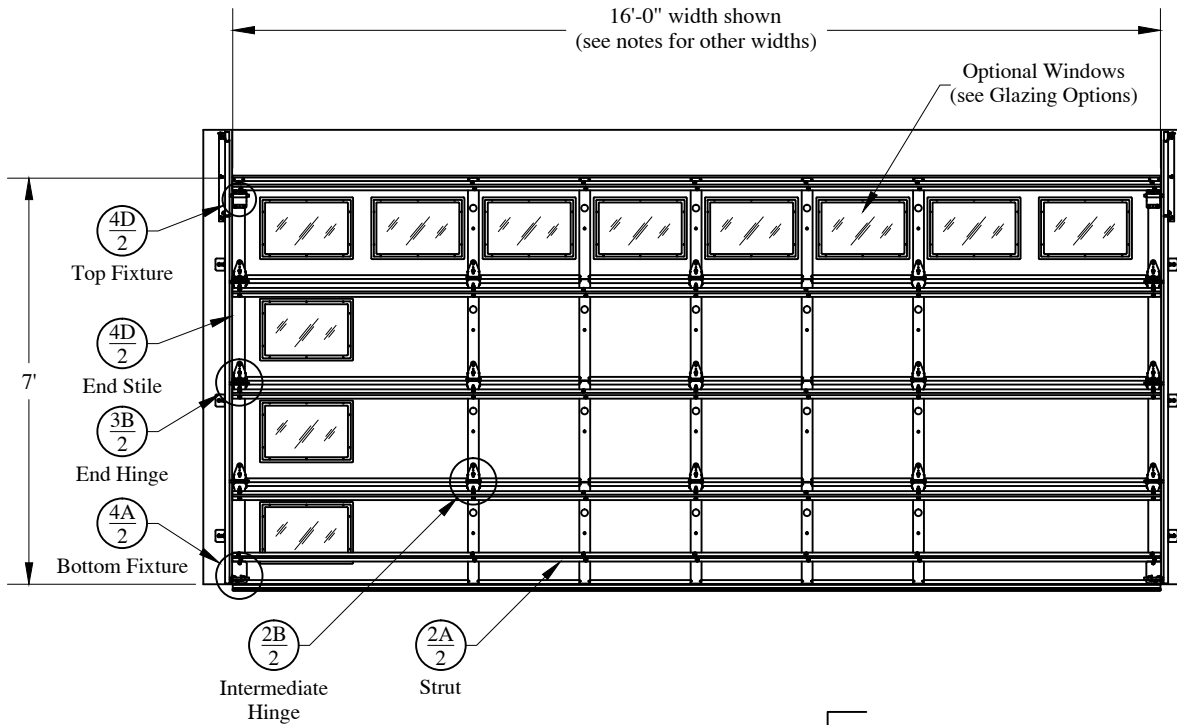

door height	section quantity	stilt quantity	trk bkkt per side
6'-6" to 7'-0"	4	5	3
7'-6" to 8'-0"	5	6	4
8'-3" to 8'-9"	5	6	4
9'-0" to 10'-6"	6	7	5
10'-9" to 12'-3"	7	8	6
12'-6" to 14'-0"	8	9	7
14'-3" to 15'-9"	9	10	8
16'-0" to 17'-6"	10	11	9
17'-9" to 19'-3"	11	12	10
19'-6" to 20'-0"	12	13	11

Track bracket quantities shown are for use with grade 2 or better Southern Yellow Pine. Refer to Jamb Attachment Detail supplemental instructions for usage of alternate jamb materials.

Supporting structural elements shall be designed by a registered professional engineer for wind loads shown on this drawing. If door is not electrically operated, a lock must be installed.

Complies with IBC/IRC 2018. Tested per ANSI/DASMA 108

Maximum door height: 20'-00"

Glazing and door have not been tested for windborne debris.

Width	Design Pressure (PSF)	Stile Qty.
11'-00"	+32.3 / -35.9	2
12'-00"	+29.6 / -32.9	3
13'-00"	+27.3 / -30.4	3
14'-00"	+25.4 / -28.2	4
15'-00"	+23.7 / -26.3	4
16'-00"	+22.2 / -24.7	5

Professional Engineer's seal provided only for verification of windload construction details

John E. Scates, P.E.  
 2560 King Arthur, Ste 124-54  
 Lewisville, TX 75056  
 TXPE 56308, F-2203  
 Florida P.E. # 51737

G.H.I.	SCALE	nts
	DATE	03-07-2022
Models Series: Pan Doors, Residential		
C.H.I. Drawing: Z4-16-01308		
page 4 of 5		

Details on some views may have been omitted for clarity.

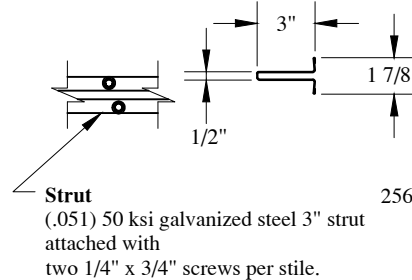
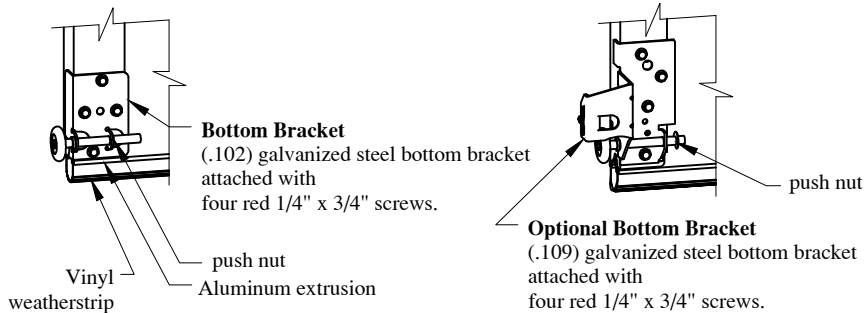
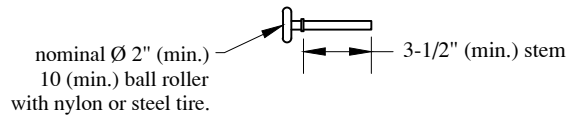
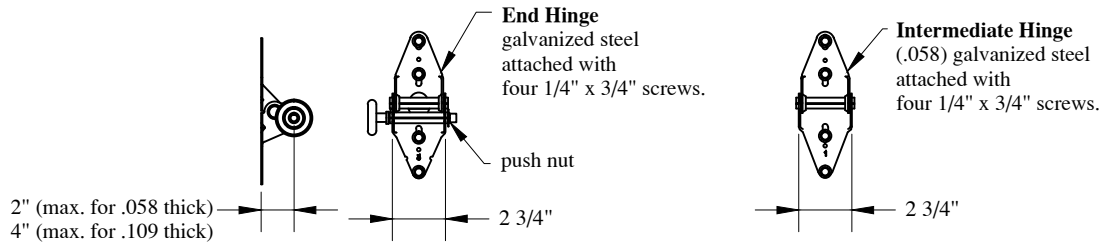
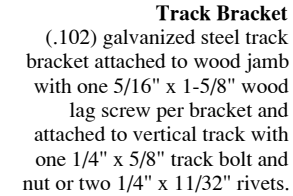
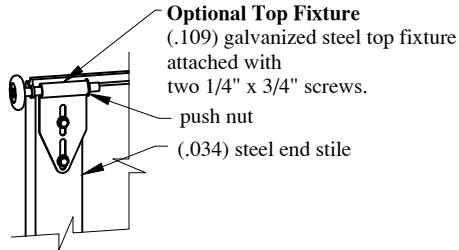
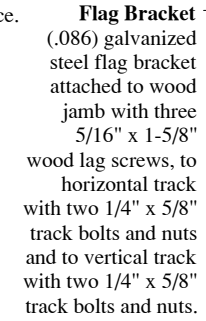
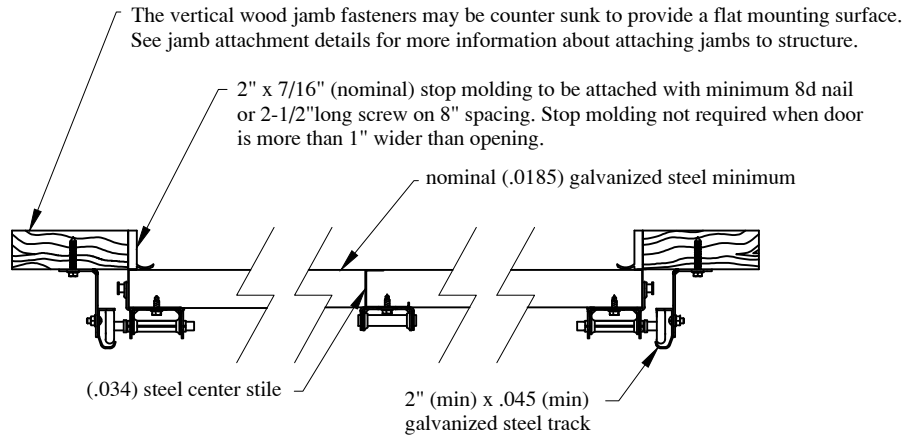
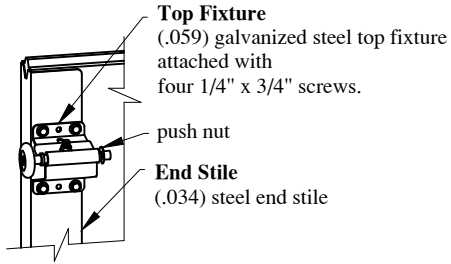

Professional Engineer's seal provided only for verification of windload construction details

John E. Scates, P.E.  
2560 King Arthur, Ste 124-54  
Lewisville, TX 75056  
TXPE 56308, F-2203  
Florida P.E. # 51737

C.H.I.	SCALE	nts
	DATE	03-07-2022
Models Series: Pan Doors, Residential		
C.H.I. Drawing: Z4-16-01308		
page 5 of 5		