

CLOPAY / IDEAL / HOLMES			
3717 / C7X17 / --	/ 27GA 1.75" THICK MINOR RIB		
3718 / C7X18 / --	/ 27GA 1.75" THICK FLUSH		
3720 / C7X20 / 240U	/ 27GA 2" THICK MINOR RIB		
3722 / COX22 / --	/ 20GA 2" THICK FLUSH		
3724 / C7X24 / 244U	/ 24GA 2" THICK MINOR RIB		
3730 / -- / --	/ 27GA 3" THICK MINOR RIB		

SHEET:
1 OF 4

REVISIONS					
REV. NO.	ZONE:	DATE:	ECN NO.	APPVD:	DESCRIPTION
05	-	08/2016	-	SH	REMOVED WIND SPEED TABLE.
06	-	02/2021	-	JDW	ADDED 3" DOOR MODEL 3730.
07	-	02/2022	-	JDW	REVISED FOR TDI.

THIS PRODUCT COMPLIES WITH THE 2018 IBC/IRC.

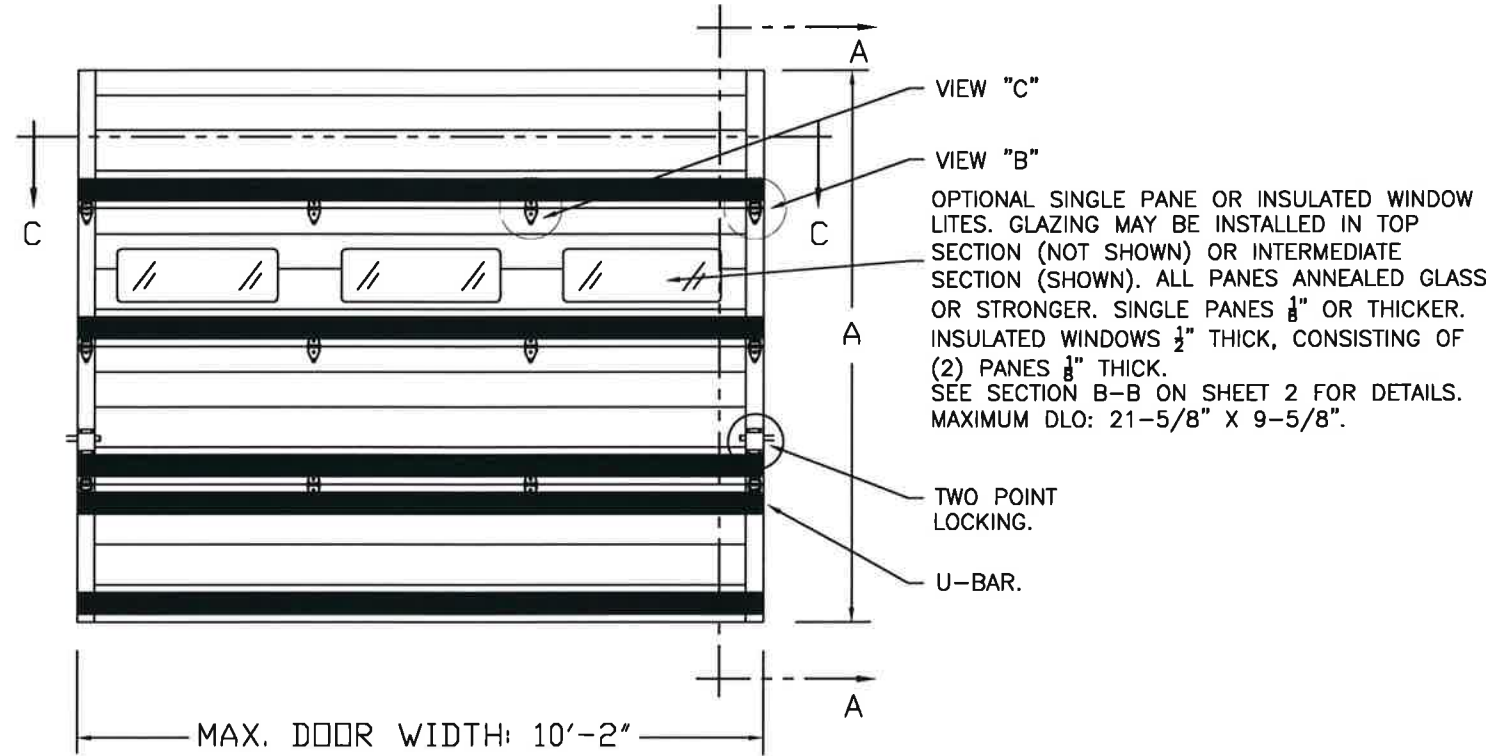

DOOR HEIGHT 'A'	NUMBER OF SECTIONS
UP TO 8'-0"	4
8'-3" THRU 10'-0"	5
10'-3" THRU 12'-0"	6
12'-3" THRU 14'-0"	7
14'-3" THRU 16'-0"	8
16'-3" THRU 18'-0"	9

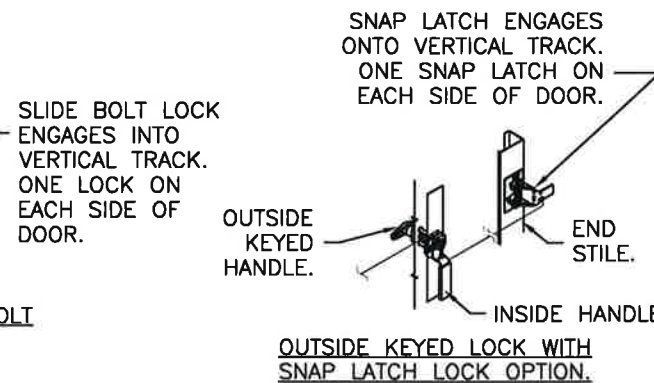
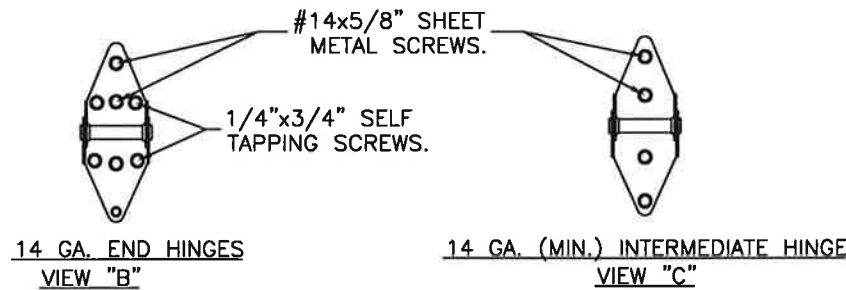

DESIGN LOADS: +37.0 P.S.F. & -44.0 P.S.F.
TEST LOADS: +55.5 P.S.F. & -66.0 P.S.F.

Unless Stated Otherwise TOLERANCES are
.0 = ±.031
.00 = ±.015
.000 = ±.005
.0000 = ±.001
Degrees = ±1/2"

Unless Stated Otherwise DIMENSIONS ARE IN INCHES.

Clopay CORPORATION
8585 Duke Boulevard
Mason, OH 45040 USA
Tel. No. 513-770-4800
Fax No. 513-770-4853

MANUFACTURING PRODUCT CODE
C-DSIU-1D477

PART NO.: N/A

WINDLOAD RATING
W6 DP37

DESCRIPTION: 1-3/4" INTELLICORE DOORS UP TO 10'2"W (SEE TABLE)

DRAWN BY: SH DATE: 2/10/14 SCALE: NTS DWG. SIZE B

CHECKED BY: SH DATE: 2/10/14 SHEET 1 OF 4

DWG. NO.: 104039 - A/B VER: TDI

DESIGN ENGINEER:
MARK WESTERFIELD, P.E.
FLORIDA P.E. #48495, NC P.E. #23832, TEXAS P.E. #91513

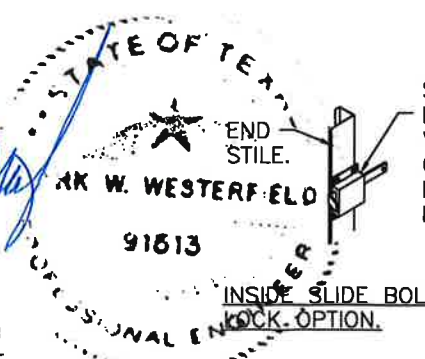

Mark Westerfield
5/31/22

CLOPAY / IDEAL / HOLMES			
3717 / C7X17 / --	/ 27GA 1.75" THICK MINOR RIB		
3718 / C7X18 / --	/ 27GA 1.75" THICK FLUSH		
3720 / C7X20 / 240U	/ 27GA 2" THICK MINOR RIB		
3722 / C0X22 / --	/ 20GA 2" THICK FLUSH		
3724 / C7X24 / 244U	/ 24GA 2" THICK MINOR RIB		
3730 / -- / --	/ 27GA 3" THICK MINOR RIB		

SHEET:
2 OF 4

REVISIONS					DESCRIPTION
REV. NO.	ZONE	DATE	ECN NO.	APPVD.	
07	-	-	-	-	SEE REVISION HISTORY ON SHEET ONE.

IMPACT-RESISTANT CONSTRUCTION:
 SOLID DOORS (NO GLAZING) OR DOORS WITH OPTIONAL IMPACT-RESISTANT GLAZING ARE IMPACT-RESISTANT. OPTIONAL IMPACT-RESISTANT ASSEMBLY CONSISTS OF ALUMINUM FRONT FRAME AND SABIC IP LEXAN 9034 (VERSIONS ALSO APPROVED: MR10, 9030, 90318, 90316, 90317, 90311, 90314, 90355) OR BAYER MAKROLON GP (VERSIONS ALSO APPROVED: STAR, 15), APPROVED CC1 PLASTICS IN ACCORDANCE WITH IBC/FBC 2606 AND APPROVED CC1 PLASTICS IN ACCORDANCE WITH FBC 2612. THE ENTIRE DOOR ASSEMBLY INSTALLED IN COMPLIANCE WITH THIS SECTION MEETS THE WIND LOAD REQUIREMENTS OF THE FLORIDA BUILDING CODE AND INTERNATIONAL BUILDING CODE AND IS LARGE- AND SMALL-MISSILE IMPACT RESISTANT.

STANDARD ASSEMBLY CONSTRUCTION:
 OPTIONAL LITES WITH DSB OR TEMPERED INSULATED GLAZING AVAILABLE.
 THE ENTIRE DOOR ASSEMBLY INSTALLED IN COMPLIANCE WITH THIS SECTION MEETS THE WIND LOAD REQUIREMENTS OF THE FLORIDA BUILDING CODE OR INTERNATIONAL BUILDING CODE BUT DOES NOT MEET THE IMPACT RESISTANT REQUIREMENT FOR WINDBORNE DEBRIS REGIONS (REF. CHAPTER 16 FBC/IBC).

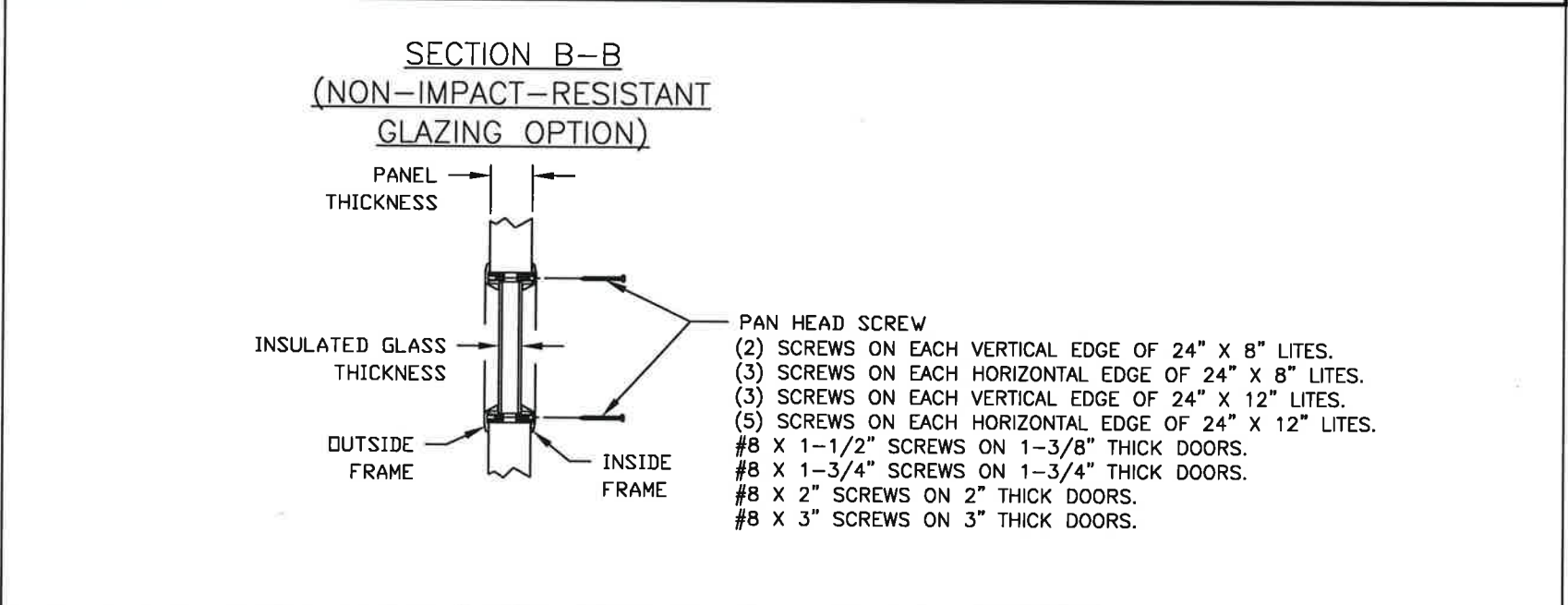
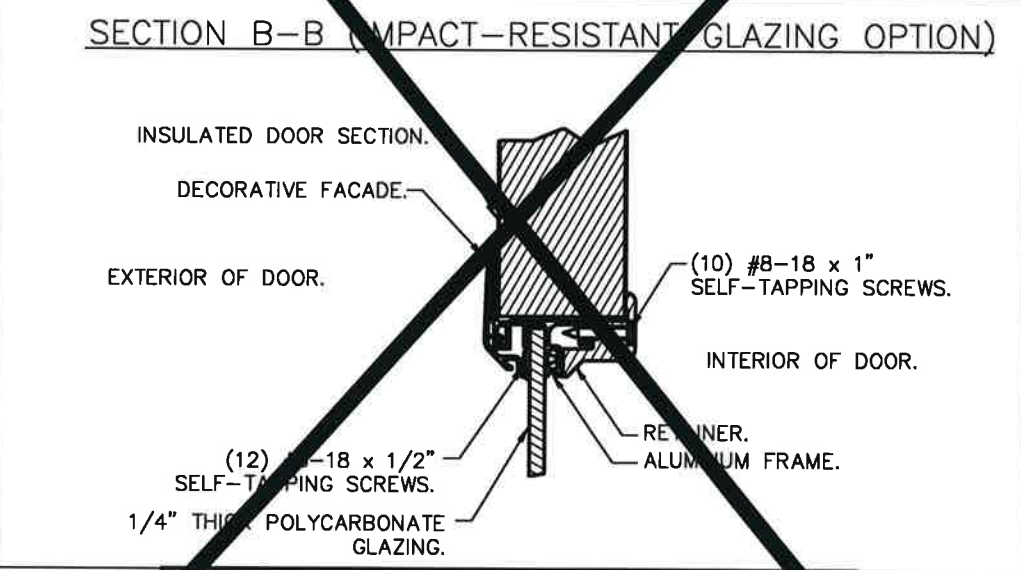

**IMPACT-RESISTANT ASSEMBLY DETAILS
 DRAWING 104039-A**

**STANDARD ASSEMBLY DETAILS
 DRAWING 104039-B**

Mark Westerfield
 5/31/22
 STATE OF TEXAS
 MARK W. WESTERFIELD
 91513
 PROFESSIONAL ENGINEER

DESIGN ENGINEER:
 MARK WESTERFIELD, P.E.
 FLORIDA P.E. #48495, NC P.E. #23832, TEXAS P.E. #91513

DESIGN LOADS: +37.0 P.S.F. & -44.0 P.S.F.
 TEST LOADS: +55.5 P.S.F. & -66.0 P.S.F.

Unless Stated Otherwise
 TOLERANCES are
 .0 = ±.031
 .00 = ±.015
 .000 = ±.005
 .0000 = ±.001
 Degrees = ±1/2'
 Unless Stated Otherwise
 DIMENSIONS ARE IN INCHES.

Glopay CORPORATION
 8585 Duke Boulevard
 Mason, OH 45040 USA
 Tel. No. 513-770-4800
 Fax No. 513-770-4853

MANUFACTURING PRODUCT CODE
 C-DSIU-1D477

PART NO.: N/A
 WINDLOAD RATING
 W6 DP37

DESCRIPTION: 1-3/4" INTELICORE DOORS UP TO 10'2"W (SEE TABLE)
 DRAWN BY: SH DATE: 2/10/14 SCALE: NTS DWG. SIZE B
 CHECKED BY: SH DATE: 2/10/14 SHEET 2 OF 4
 DWG. NO.: 104039 - A/B VER: TDI

CLOPAY / IDEAL / HOLMES			
3717	/ C7X17 /	--	/ 27GA 1.75" THICK MINOR RIB
3718	/ C7X18 /	--	/ 27GA 1.75" THICK FLUSH
3720	/ C7X20 /	240U	/ 27GA 2" THICK MINOR RIB
3722	/ COX22 /	--	/ 20GA 2" THICK FLUSH
3724	/ C7X24 /	244U	/ 24GA 2" THICK MINOR RIB
3730	/ -- /	--	/ 27GA 3" THICK MINOR RIB

SHEET:
3 OF 4

REVISIONS					DESCRIPTION
REV. NO.	ZONE	DATE	ECN NO.	APPVD.	
07	-	-	-	-	SEE REVISION HISTORY ON SHEET ONE.

JAMB TO SUPPORTING STRUCTURE ATTACHMENT

- NOTES:**
1. ALL THE LOAD FROM THE DOOR IS TRANSFERRED TO THE TRACK AND THEN FROM THE TRACK TO THE 2x6 VERTICAL SYP (GRADE #2 OR BETTER) JAMBS. NO LOAD FROM THE DOOR IS TRANSFERRED TO THE HORIZONTAL (TOP) JAMB.
 2. EACH VERTICAL JAMB SEES A MAXIMUM DESIGN LOAD OF +185 LB & -220 LB. PER LINEAR FOOT OF JAMB.
 3. ALL JAMB FASTENERS MAY BE (BUT ARE NOT REQUIRED TO BE) COUNTERSUNK TO PROVIDE A FLUSH MOUNTING SURFACE.
 4. A 1/3 STRESS INCREASE FOR WIND LOAD WAS NOT USED IN THE CALCULATION OF ALLOWABLE LOADS FOR ANCHORS AND FASTENERS FOR STEEL, CONCRETE AND MASONRY.

NOTE: 2x6 WOOD JAMBS ARE NOT REQUIRED WITH CONTINUOUS ANGLE MOUNT TRACK. HOWEVER, IF DESIRED ON STEEL JAMBS OR CONCRETE OR BLOCK WALLS, APPROVED FASTENERS AS DETAILED BELOW SHOULD BE INCREASED IN LENGTH BY 1-1/2" AND INSTALLED DIRECTLY THROUGH THE ANGLE AND 2x6 WOOD JAMBS INTO THE STEEL JAMBS OR CONCRETE OR BLOCK WALLS. ANCHORS CAN BE (BUT ARE NOT REQUIRED TO BE) COUNTERSUNK TO PROVIDE A FLUSH MOUNTING SURFACE. CONTINUOUS ANGLE TRACK CAN BE ANCHORED DIRECTLY TO GROUT REINFORCED BLOCK WALL OR 3,000 PSI MIN. CONCRETE COLUMN OR STEEL JAMBS.

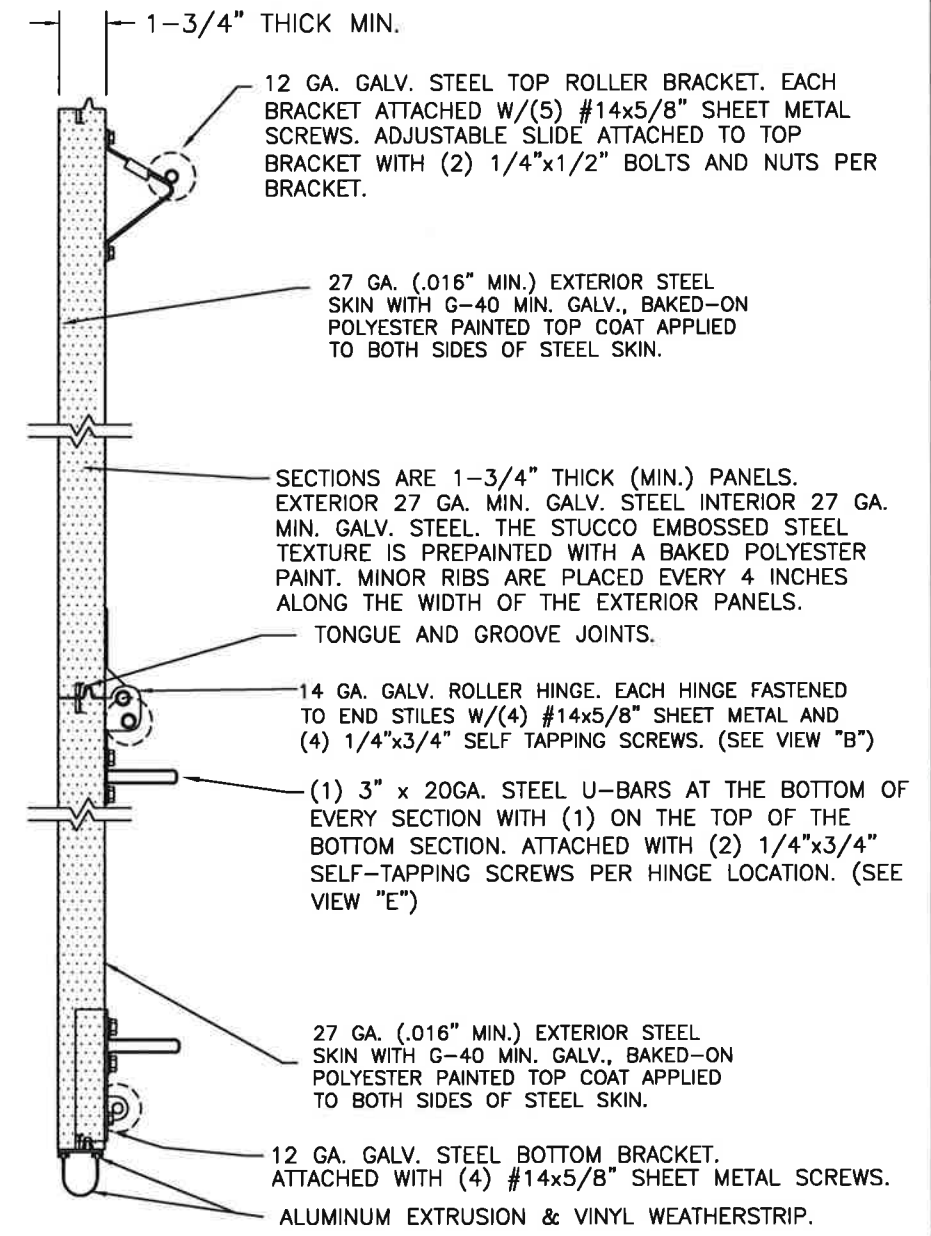
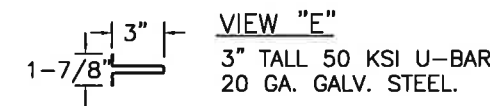
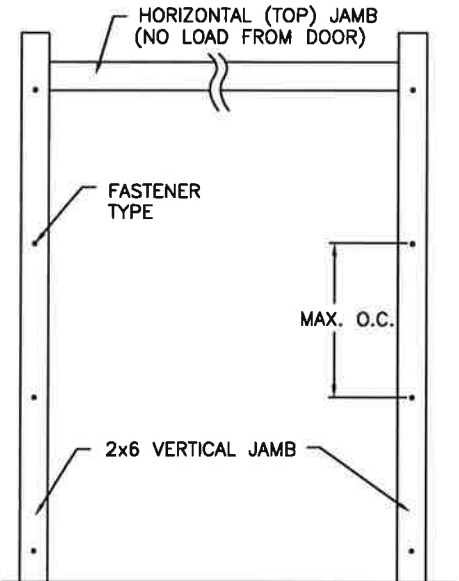

FASTENER ATTACHMENT TO SUPPORTING STRUCTURE SCHEDULES

BUILDING TYPE	FASTENER TYPE	MAXIMUM ON-CENTER DISTANCE BETWEEN FASTENERS*	STEEL WASHERS REQUIRED?
HOLLOW BLOCK WALL	1/4" x 1-1/4" MIN. EMBED ULTRACON CONCRETE ANCHOR	9"	1" O.D.
GROUT FILLED BLOCK WALL	1/4" x 1-3/4" MIN. EMBED ULTRACON CONCRETE ANCHOR	14-3/4"	1" O.D.
2000 PSI MIN. CONCRETE	1/4" x 1" MIN. EMBED ULTRACON CONCRETE ANCHOR	12-3/4"	1" O.D.
2000 PSI MIN. CONCRETE	1/4" x 1" MIN. EMBED TAPCON CONCRETE ANCHOR	11"	1" O.D.
2000 PSI MIN. CONCRETE	3/8" x 1-3/4" MIN. EMBED WEJ-IT ANKR TITE SLEEVE ANCHOR	24"	INCLUDED
4000 PSI MIN. CONCRETE	3/8" x 1-3/4" MIN. EMBED WEJ-IT ANKR TITE SLEEVE ANCHOR	24"	INCLUDED
WOOD FRAME (SYP 0.55 SG)	1/2" x 3" LAG SCREW (ASTM A307, GRADE A) 1-5/8" EMBED INTO STRUCTURE	24"	1" O.D.
14GA STEEL (0.060" MIN.)	1/4"-14 x 1" ITW BUILDEX TEKS SELF-DRILLING FASTENER	12-1/4"	1" O.D.
12GA STEEL (0.105" MIN.)	1/4"-14 x 1" ITW BUILDEX TEKS SELF-DRILLING FASTENER	21-1/2"	1" O.D.
1/8" STEEL	1/4"-14 x 1" ITW BUILDEX TEKS SELF-DRILLING FASTENER	24"	1" O.D.

*FIRST (BOTTOM) ANCHOR STARTING AT NO MORE THAN HALF OF THE MAXIMUM ON-CENTER DISTANCE. HIGHEST ANCHOR INSTALLED AT LEAST AS HIGH AS THE DOOR OPENING.
CLOPAY DOES NOT SUPPLY JAMB ATTACHMENT FASTENERS.
MINIMUM DISTANCE BETWEEN CENTER OF ANCHOR AND EDGE OF CONCRETE BLOCK: 2-1/2", EXCLUDING STUCCO THICKNESS.

STATE OF TEXAS
K W WESTERFIELD
91513
5/31/22
DESIGN ENGINEER
MARK WESTERFIELD, P.E.
FLORIDA P.E. #48495, NC P.E. #23832, TEXAS P.E. #91513

DESIGN LOADS: +37.0 P.S.F. & -44.0 P.S.F.
TEST LOADS: +55.5 P.S.F. & -66.0 P.S.F.

Unless Stated Otherwise
TOLERANCES are
.0 = ±.031
.00 = ±.015
.000 = ±.005
.0000 = ±.001
Degrees = ±1/2"
Unless Stated Otherwise
DIMENSIONS ARE IN INCHES.

Glopay
CORPORATION
8585 Duke Boulevard
Mason, OH 45040 USA
Tel. No. 513-770-4800
Fax No. 513-770-4853

MANUFACTURING PRODUCT CODE
C-DSIU-1D477

PART NO.: N/A

WINDLOAD RATING
W6 DP37

DESCRIPTION: 1-3/4" INTELLICORE DOORS UP TO 10'2"W (SEE TABLE)	DATE: 2/10/14	SCALE: NTS	DWG. SIZE: B
DRAWN BY: SH	DATE: 2/10/14	SHEET 3 OF 4	
CHECKED BY: SH	DATE: 2/10/14	DWG. NO.: 104039 - A/B	VER: TDI

CLOPAY / IDEAL / HOLMES			
3717 / C7X17 / --	/ 27GA 1.75" THICK MINDR RIB		
3718 / C7X18 / --	/ 27GA 1.75" THICK FLUSH		
3720 / C7X20 / 240U	/ 27GA 2" THICK MINDR RIB		
3722 / COX22 / --	/ 20GA 2" THICK FLUSH		
3724 / C7X24 / 244U	/ 24GA 2" THICK MINDR RIB		
3730 / -- / --	/ 27GA 3" THICK MINDR RIB		

**2" TRACK CONFIGURATION
DOORS UP TO 800 LBS.**

NOTE DOUBLE TRACK HEADROOM, HI-LIFT TRACK, FOLLOW-THE-ROOF TRACK, AND VERTICAL LIFT TRACK ARE AVAILABLE OPTIONS. TRACK CONFIGURATION ABOVE THE DOOR OPENING DOES NOT AFFECT THE WIND LOAD RATING.

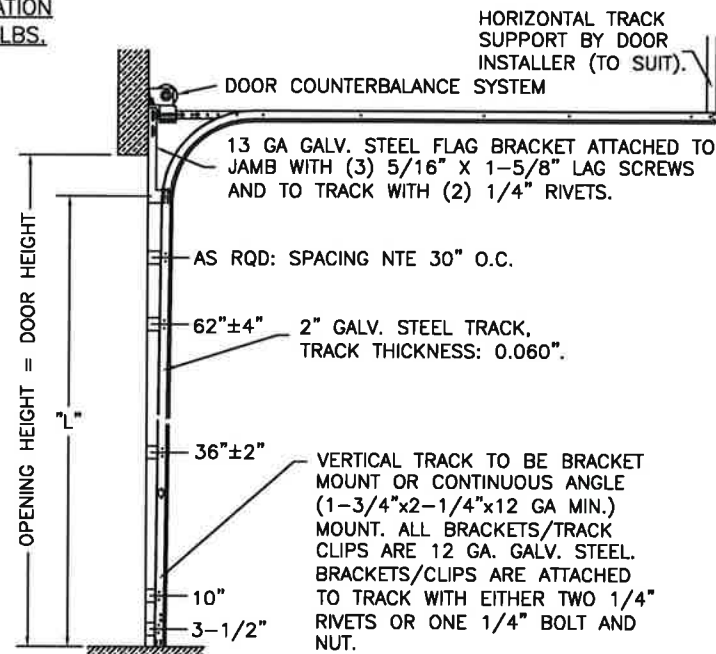

DOOR HEIGHT	"L"
6'-6"	70"
7'-0"	76"
7'-6"	82"
8'-0"	88"
8'-6"	94"
9'-0"	100"
9'-6"	106"
10'-0"	112"
10'-6"	118"
11'-0"	124"
11'-6"	130"
12'-0"	136"
12'-6"	142"
13'-0"	148"
13'-6"	154"
14'-0"	160"
14'-6"	166"
15'-0"	172"
15'-6"	178"
16'-0"	184"
16'-6"	190"
17'-0"	196"
17'-6"	202"
18'-0"	208"

**JAMB CONFIGURATION
DOORS UP TO 800 LBS.**

BRACKET MOUNT JAMB CONFIGURATION

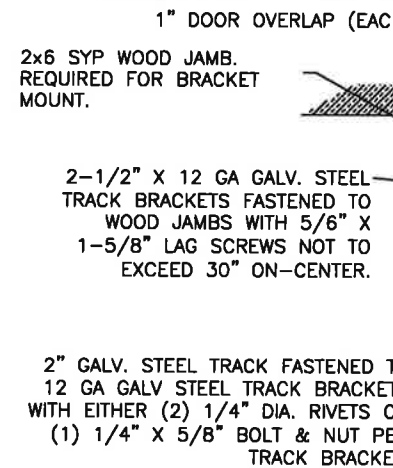

ANGLE MOUNT JAMB CONFIGURATION

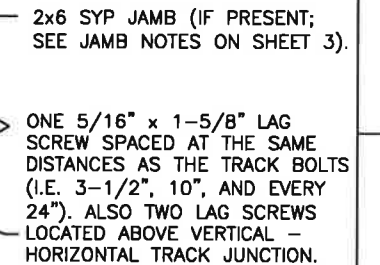

**SECTION C-C
PREPARATION OF JAMBS BY OTHERS.**

LHR BRACKET (2-1/2" x 5-3/4" x 12GA) ATTACHED WITH (2) 1/4" x 3/4" SELF TAPPING SCREWS.



**DOUBLE TRACK
LOW HEADROOM OPTION**
(AVAIL. FOR BOTH 2" AND 3" TRACK)

DOUBLE HORIZONTAL TRACK.

**3" TRACK CONFIGURATION
DOORS 800 LBS AND OVER.**

NOTE DOUBLE TRACK HEADROOM, HI-LIFT TRACK, FOLLOW-THE-ROOF TRACK, AND VERTICAL LIFT TRACK ARE AVAILABLE OPTIONS. TRACK CONFIGURATION ABOVE THE DOOR OPENING DOES NOT AFFECT THE WIND LOAD RATING.

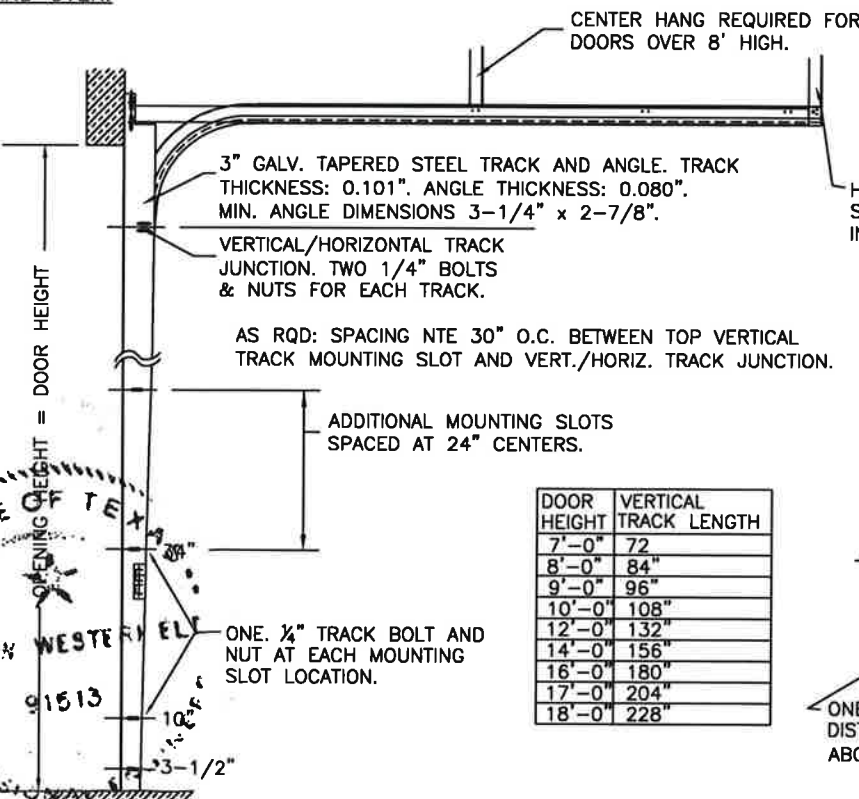

DOOR HEIGHT	VERTICAL TRACK LENGTH
7'-0"	72"
8'-0"	84"
9'-0"	96"
10'-0"	108"
12'-0"	132"
14'-0"	156"
16'-0"	180"
17'-0"	204"
18'-0"	228"

**JAMB CONFIGURATION
DOORS 800 LBS AND OVER.**

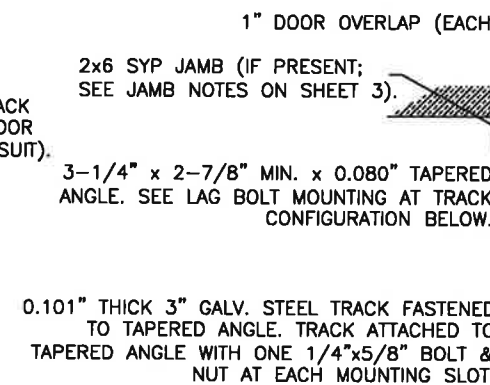

18 GA. GALV. STEEL CENTER HINGE FASTENED TO SECTION W/(4) EACH #14x5/8" SHEET METAL SCREWS.

**SECTION C-C
PREPARATION OF JAMBS BY OTHERS.**

DESIGN LOADS: +37.0 P.S.F. & -44.0 P.S.F.
TEST LOADS: +55.5 P.S.F. & -66.0 P.S.F.

Unless Stated Otherwise
TOLERANCES are
.0 = ±.031
.00 = ±.015
.000 = ±.005
.0000 = ±.001
Degrees = ±1/2"

Unless Stated Otherwise
DIMENSIONS ARE IN INCHES.

Glopay CORPORATION
8585 Duke Boulevard
Mason, OH 45040 USA
Tel. No. 513-770-4800
Fax No. 513-770-4853

MANUFACTURING PRODUCT CODE
C-DSIU-1D477

PART NO.: N/A

WINDLOAD RATING
W6 DP37

DESCRIPTION: 1-3/4" INTELLICORE DOORS UP TO 10'2"W (SEE TABLE)

DRAWN BY: SH	DATE: 2/10/14	SCALE: NTS	DWG. SIZE B
CHECKED BY: SH	DATE: 2/10/14	SHEET 4 OF 4	

DWG. NO.: 104039 - A/B

VER: TDI

DESIGN ENGINEER:
MARK WESTERFIELD, P.E.
FLORIDA P.E. #48495, NC P.E. #23892, TEXAS P.E. #91513

Mark Westerfield
5/31/22