

BILL OF MATERIALS FOR HINGED PATIO DOOR OF 8'0" HEIGHT-OUTSWING (Water=DP70)

ITEM NO.	QTY	PART DESCRIPTION	MATERIALS
1	6	HEAD FRAME & JAMB	FOAM PVC CO-EX
2	2	OUTSWING SILL-A	FOAM PVE CO-EX
11	2	OUTSWING SILL-B	ALUMINUM
18	2	WEATHER STRIP(A)	PP & TPE
19	6	WEATHER STRIP(B)	FOAM PU .PE FILM. ELON
27	8	DOOR HINGE	STEEL
20	2	CORNER PAD	FOAM PU .PE FILM
33	2	TOP/BOTTOM BAR KEEPER	STAINLESS STEEL
21	4	DOOR/LITE FRAME	FOAM PVC
22	4	DOOR GAP PLANK	FOAM PVC
16	1	MULLION COVER (B)	FOAM PVC
17	1	REINFORCEMENT (B)	ALUMINUM
35	1	SILL RISER	ALUMINUM
50	34	#10 X 3" PHILLIPS FLAT HEAD	SHEET METAL
51	22	#10 X 2 1/2" PHILLIPS FLAT HEAD	SHEET METAL
52	25	#10 X 2" PHILLIPS FLAT HEAD	SHEET METAL
3	6	STILE-(A)	FOAM PVC
4	1	STILE-(B)	FOAM PVC
5	1	STILE-(C)	FOAM PVC
6	8	TOP & BOTTOM RAIL	FOAM PVC
8	1	REIN. WOOD-(B)	WOOD
9	23	REIN. WOOD-(C)	WOOD
10	4	REIN. WOOD-(D)	WOOD
36	40	NYLON SCREW	NYLON66
37	8	1/8" REIN. STEEL	SPHC
12	2	DOOR BOTTOM-(A)	RIGID PVC CO-EX
13	2	DOOR BOTTOM-(B)	RIGID PVC CO-EX
14	2	ASTRAGL. (A)	RIGID PVC
15	2	REINFORCEMENT	ALUMINUM
24	2	ASTRAGL. TOP CAP	RIGID PVC
25	2	ASTRAGL. BOTTOM CAP	RIGID PVC
23	2	DRIVE BAR PLATE	RIGID PVC
28	2	FLUSH BOLT BAR	STAINLESS STEEL
29	2	FLUSH BOLT MECHANISM	STAINLESS STEEL
30	1	MULTI-POINT LOCKING SYSTEM	DIE CAST. STEEL, POM
31	1	HANDLE SETS	DIE CAST
32	2	HEAVY HOOK KEEPER	STAINLESS STEEL
34	1	SLAB MULTI-POINT LOCK KEEPER	STAINLESS STEEL
40	8	Sheet Molding Compound SKIN	FIBERGLASS
52	48	#10 X 2" PHILLIPS FLAT HEAD	SHEET METAL
53	4	#10 X 7/8" PHILLIPS FLAT HEAD	SHEET METAL
54	4	#9 X 1 1/2" PHILLIPS FLAT HEAD	SHEET METAL
55	4	#9 X 7/8" PHILLIPS FLAT HEAD	SHEET METAL

ACTIVE, PASSIVE,
AND
STATIONARY
PANEL (A7P)

**TEST SPECIMEN COMPLIES
WITH THESE DETAILS, ANY
DEVIATION IS NOTED.
REPORT NO. NCTL - 210 - 4112-04
TEST DATE: 07/20/18**

DATE	AUG/02/2018	SHEET	8'0" Height Outswing Patio Door OXXO
DRAWN BY	Ruskin Wu	1 of 12	Bill of Materials (Water=DP70)
DWG NO.			
REVISIONS			



NAN YA PLASTICS CORPORATION
6F, 201, Tunq Hwa N, Road Taipei, Taiwan
Tel: (886) 2 2712 2211 Fax: (886) 2 2717 4912

146 7/16" [3719.5]

UNIT DIM=109 1/16" [2770.2]

37 3/8" [949.3]

97 3/16" [2468.6]

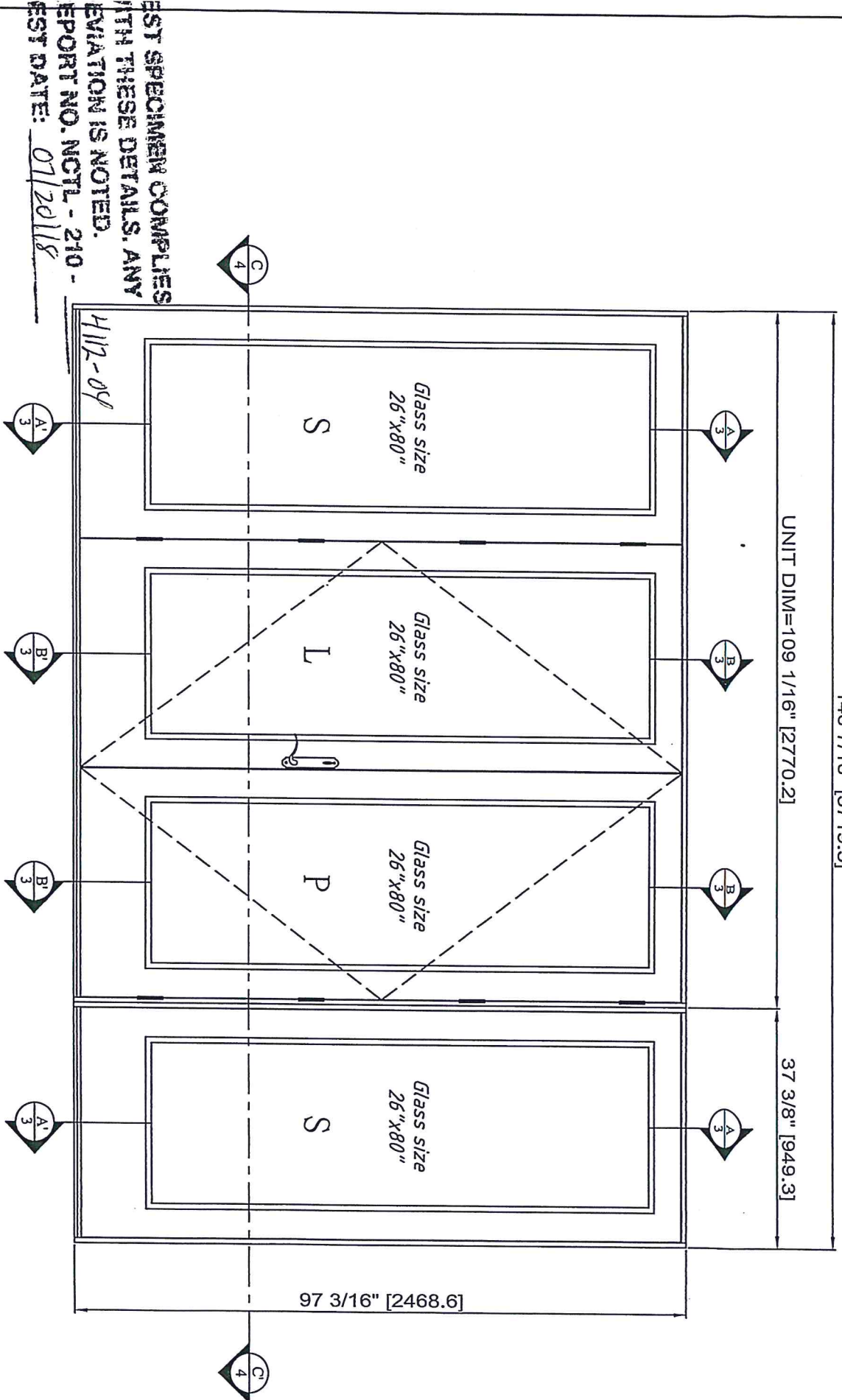

BEST SPECIMEN COMPLIES WITH THESE DETAILS. ANY DEVIATION IS NOTED.

REPORT NO. NCTL - 210 -

TEST DATE: 07/2018

Exterior view shown
 S: Stationary
 L: Active panel of hinge at left side
 P: Passive panel

8'0" Height Outswing (146 7/16" X 97 3/16")
 AAMA A440-11 & A440S1-17 / ASTM E1886 / ASTM E1996 / TAS201, 202, 203

DATE	Aug/02/2018	SHEET	8'0" Height Outswing Patio Door OXXO	 NAN YA PLASTICS CORPORATION OFL201, Tung Hua N. Road Taipei, Taiwan Tel: (886)2-2712-2311 ; Fax: (886)2-2717-8512
DRAWN BY	Ruskin Wu	2 of 12	(146 7/16" X 97 3/16")	
REVISIONS	DWG NO.			

A Frame Head
Stationary

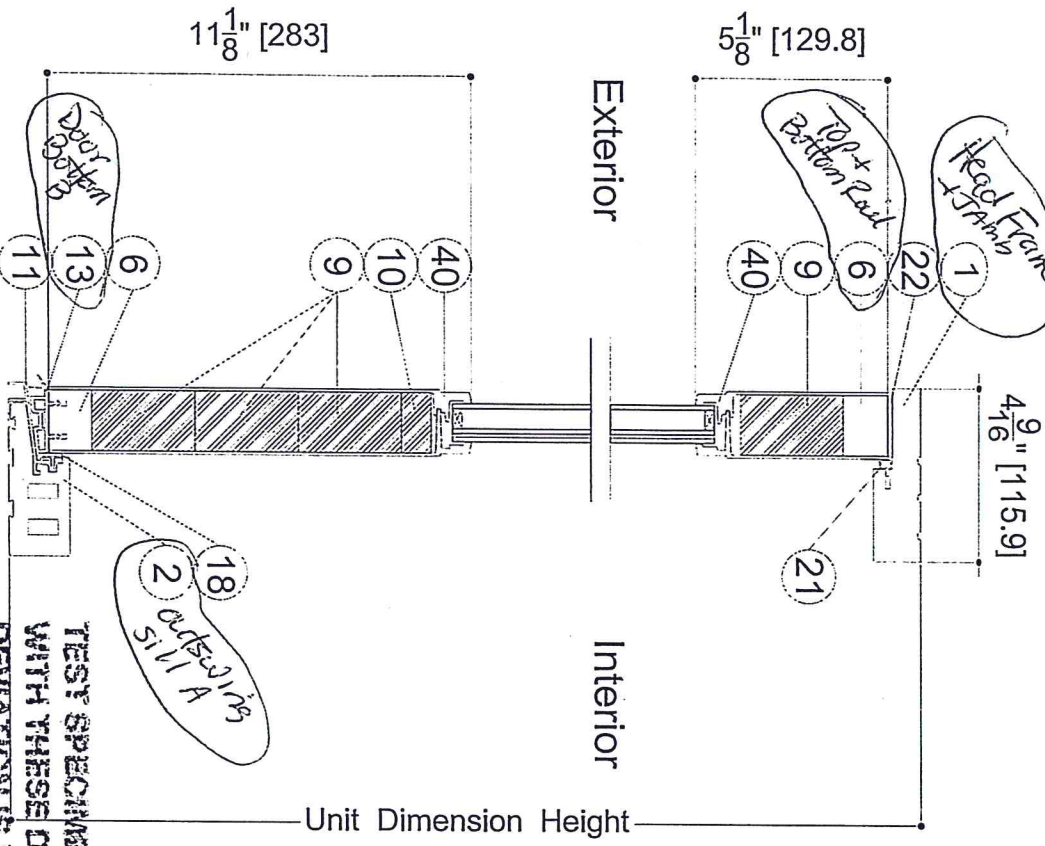

A' Threshold
Stationary

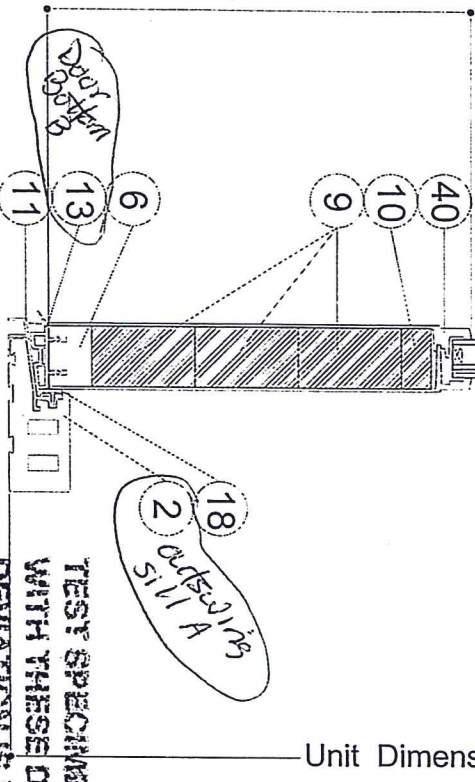

B Frame Head
Active/Passive

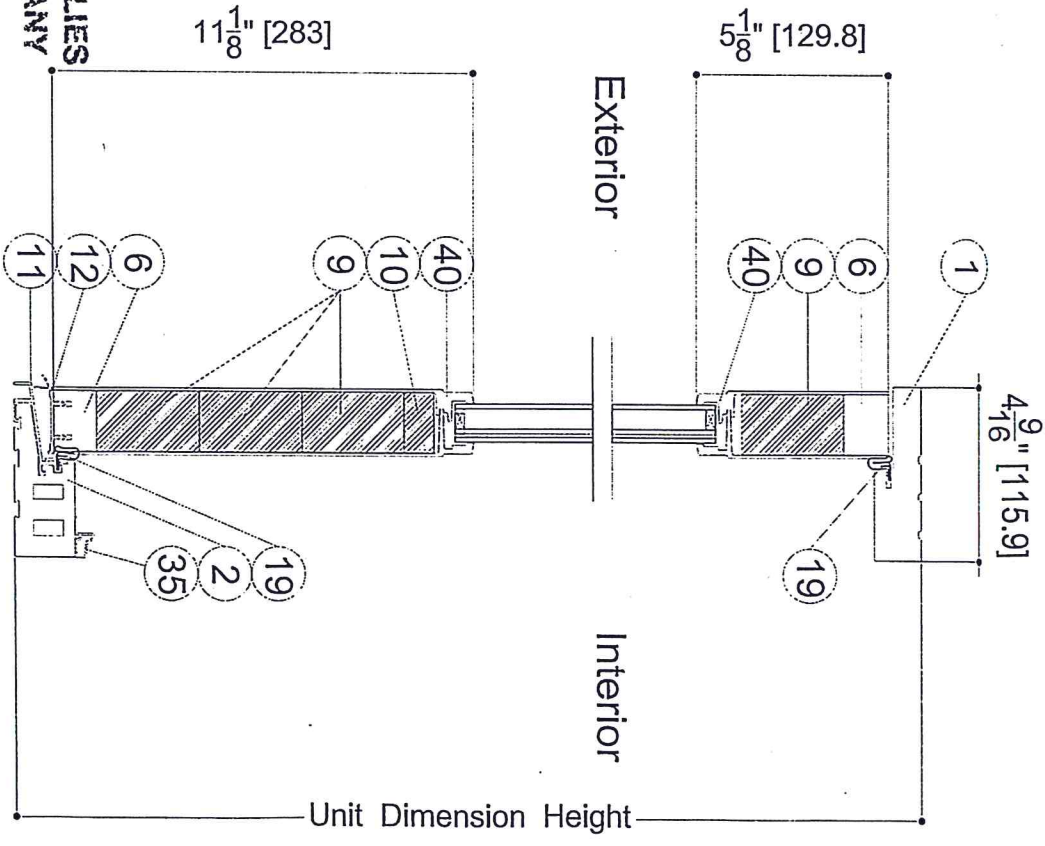

B' Threshold
Active/Passive

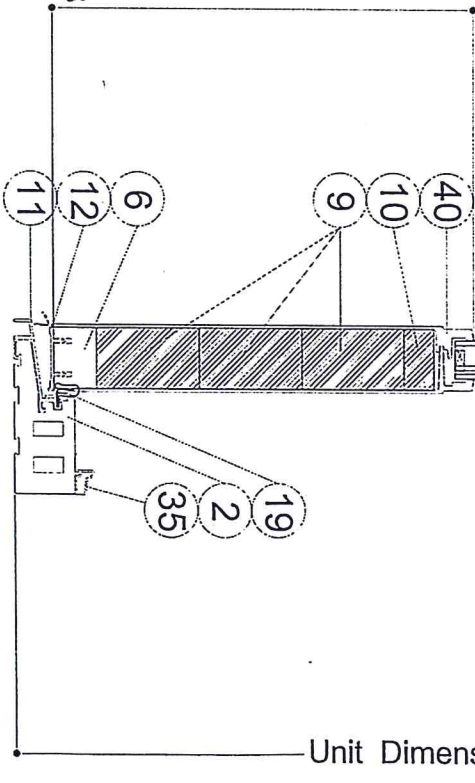

TEST SPECIMEN COMPLIES WITH THESE DETAILS. ANY DEVIATION IS NOTED.
REPORT NO. NCTL - 210 - 4/18-04
TEST DATE: 07/20/18

DATE	Aug/02/2018	SHEET	3 of 12	SHEET TITLE:	80" Height Outswinging Patio Door OXXO A-A' & B-B' Vertical Section (Water=DP70)
DRAWN BY	Ruskin Wu				
DWG NO.					
REVISIONS					

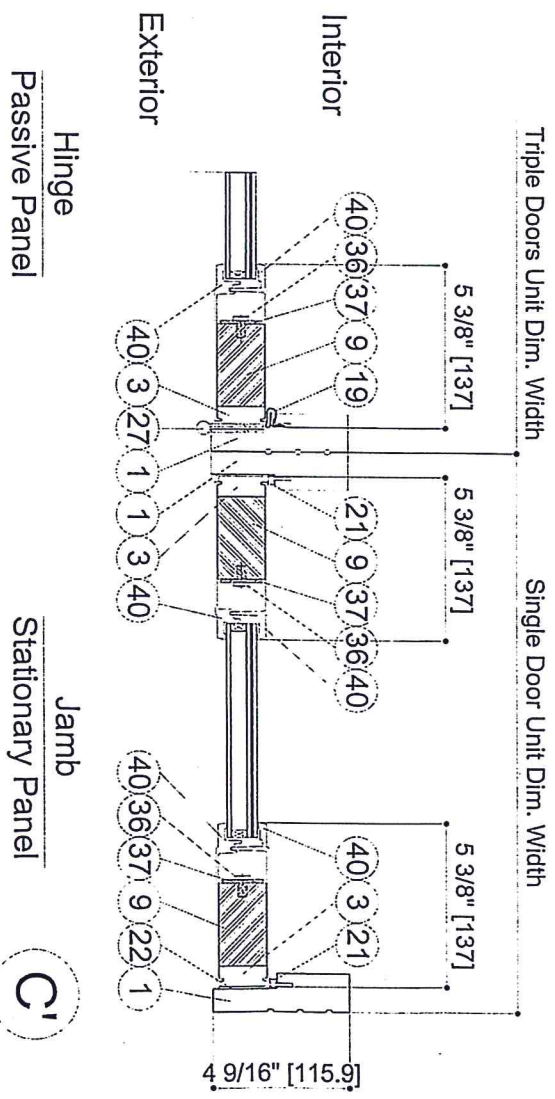
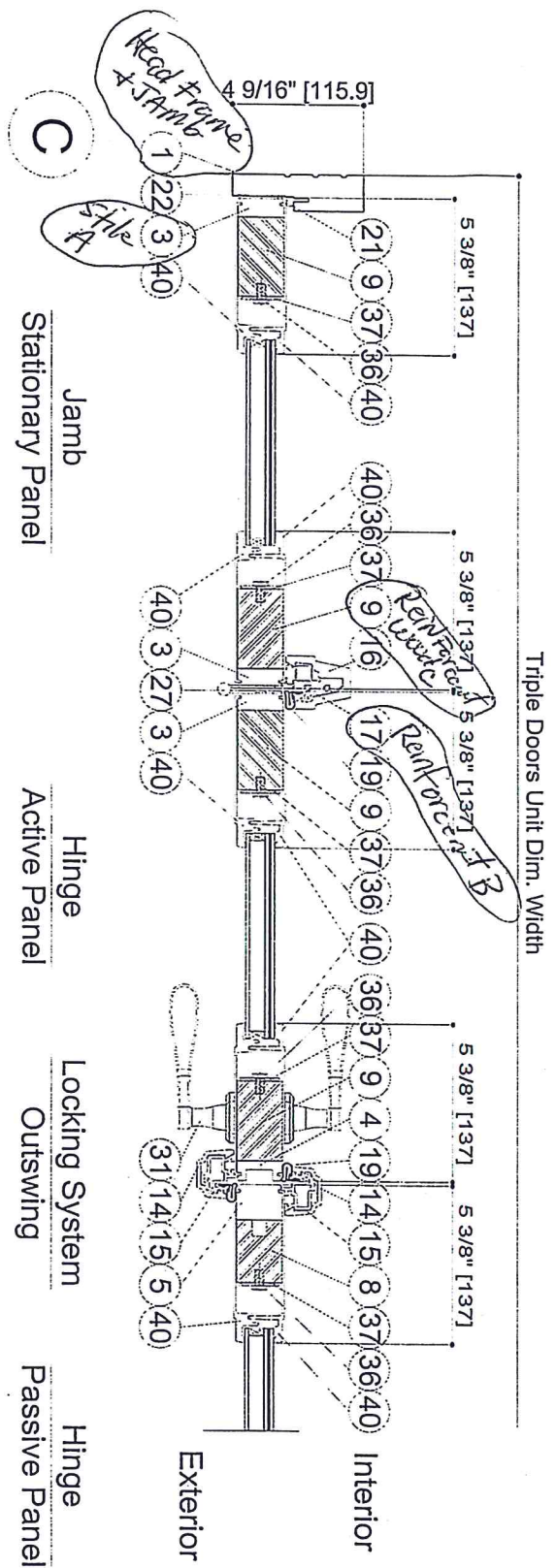

TEST SPECIMEN COMPLIES WITH THESE DETAILS. ANY DEVIATION IS NOTED.
REPORT NO. NCTL - 210 - 4112-04
TEST DATE: 07/20/18

REVISIONS	DATE	DRAWN BY	DWG NO.	SHEET	SHEET TITLE:	80" Height Outswing Patio Door OXXX C-C' Horizontal Section (Water=DP70)
	Aug/02/2018	Ruskin Wu		4 of 12		

NAN YA PLASTICS CORPORATION
 GFL-201, Tung Hua N. Road Taipei, Taiwan
 Tel: (886)2-2712-2211 ; Fax: (886)2-2717-5512

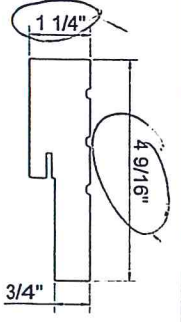

1 HEAD FRAME & JAMB
FOAM PVC CO-EX.

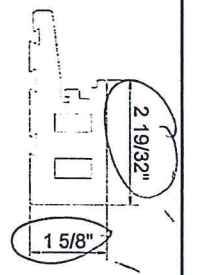

2 OUTSWING SILL-(A)
FOAM PVC CO-EX.

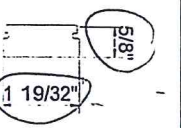

3 STILE-(A)
FOAM PVC

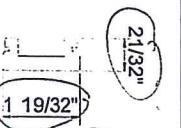

4 STILE-(B)
FOAM PVC

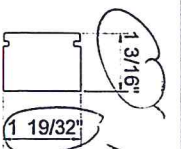

5 STILE-(C)
FOAM PVC

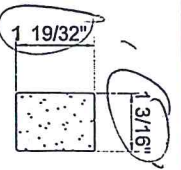

6 TOP & Bottom RAIL
FOAM PVC

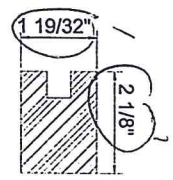

8 REIN. WOOD-(B)
Wood

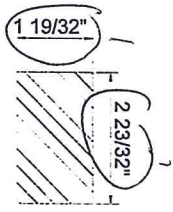

9 REIN. WOOD-(C)
Wood

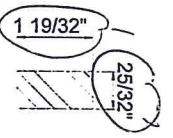

10 REIN. WOOD-(D)
Wood

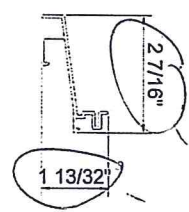

11 OUTSWING SILL-(B)
ALUMINUM

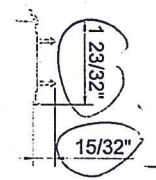

12 DOOR BOTTOM-(A)
RIGID PVC CO-EX

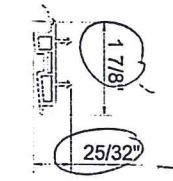

13 DOOR BOTTOM-(B)
RIGID PVC CO-EX

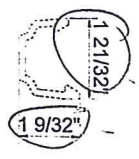

14 ASTRAGAL (A)
RIGID PVC

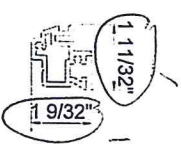

15 REINFORCEMENT(A)
ALUMINUM

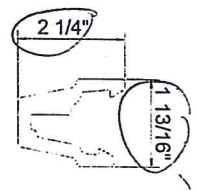

16 MULLION COVER (B)
FOAM PVC

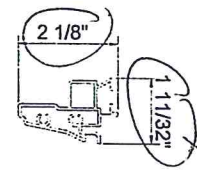

17 REINFORCEMENT (B)
ALUMINUM

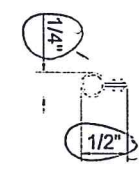

18 WEATHER STRIP(A)
PP&TPE

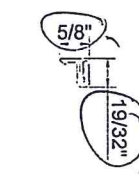

19 WEATHER STRIP(B)
FOAM PU ,PE FILM, E LON

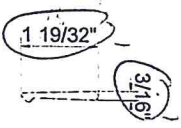

20 CORNER PAD
FOAM PU ,PE FILM

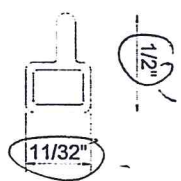

21 DOORLITE FRAME
FOAM PVC

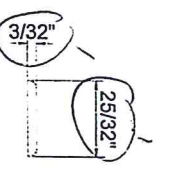

22 DOOR GAP PLANK
FOAM PVC

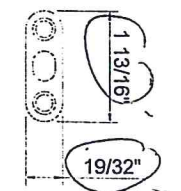

23 DRIVE BAR PLATE
STAINLESS STEEL

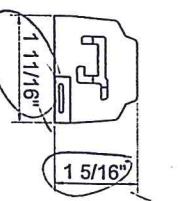

24 ASTRAGAL TOP CAP
RIGID PVC

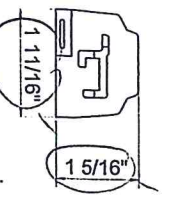

25 ASTRAGAL BOTTOM CAP
RIGID PVC

**WITH THESE DETAILS ANY
TEST SPECIMEN COMPLIES**

DEVIATION IS NOTED AUG/02/2018

REPORT NO. 111-04
DRAWN BY Ruskin Wu
DWG NO. 111-04

REVISIONS DATE: 07/20/15

SHEET 5 of 12

SHEET TITLE:
80" Height Outswing Patio Door OXXO
Door Hardware & Accessories (Water=DP70) -1

NAN YA PLASTICS CORPORATION
6FL-201, Tung Kwai N. Road TaiPo, Taiwan
Tel: (886)2-2712-2211 Fax: (886)2-2717-4512

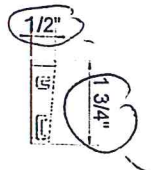

26 BOTTOM CAP(L/R)
RIGID PVC



27 DOOR HINGE
STEEL

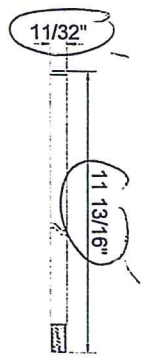

28 FLUSH BOLT BAR
STAINLESS STEEL

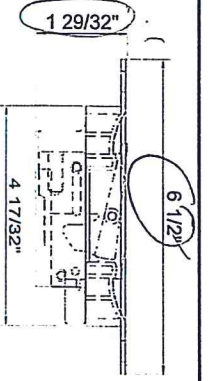

29 FLUSH BOLT MECHANISM
DIE CAST, STEEL, POM

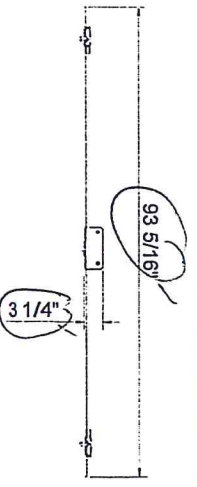

30 MULTI-POINT LOCKING SYSTEM
STAINLESS STEEL, STEEL

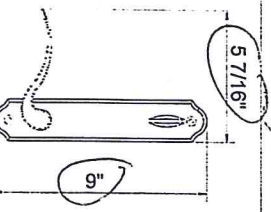

31 HANDLE SETS
DIE CAST

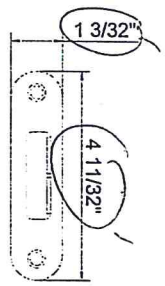

32 HEAVY HOOK KEEPER
STAINLESS STEEL

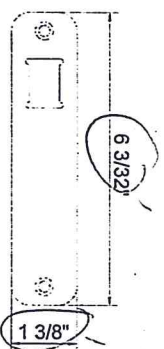

33 TOP/BOTTOM BAR KEEPER
STAINLESS STEEL

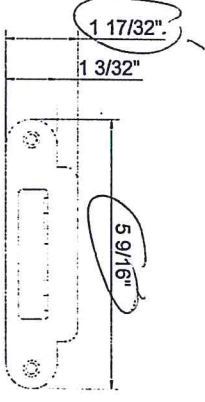

34 SLAB MULTI-POINT LOCK KEEPER
STAINLESS STEEL

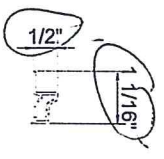

35 SILL RISER
ALUMINIUM

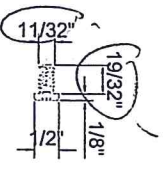

36 NYLON SCREW
NYLON66

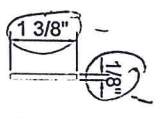

37 1/8" REIN. STEEL
SPHC

TEST SPECIMEN COMPLIES
WITH THESE DETAILS. ANY
DEVIATION IS NOTED.
REPORT NO. NOTL - 210 - 4112 - 04
TEST DATE: 07/20/18

DATE	AUG/02/2018	SHEET	6 of 12	SHEET TITLE:	80" Height Outswing Patio Door OXXO Door Hardware & Accessories (Water=DP70) -2	NAN YA PLASTICS CORPORATION 6FL-201, Tung Hua N. Road Taipei, Taiwan Tel:(886)2-2712-2211 ; Fax:(886)2-271-6512
DRAWN BY	Ruskin Wu					
DWG NO.						
REVISIONS						

8'0" A7P Outswing Active Panel Details

Door Slab Size: 35 3/4" X 95 1/4"

Glass : 26" X 80"

D.O : 25" X 79"

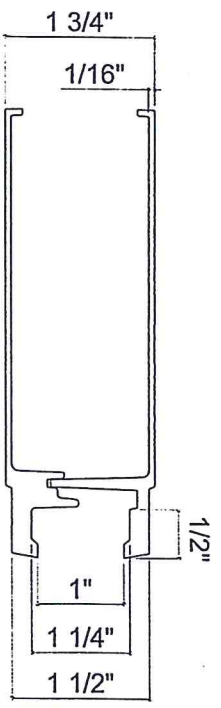
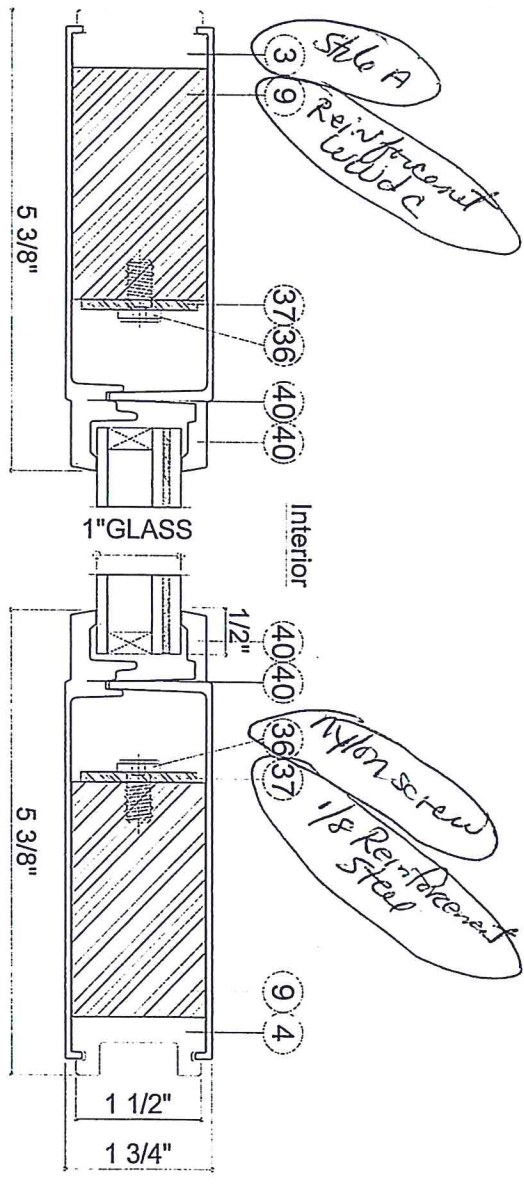
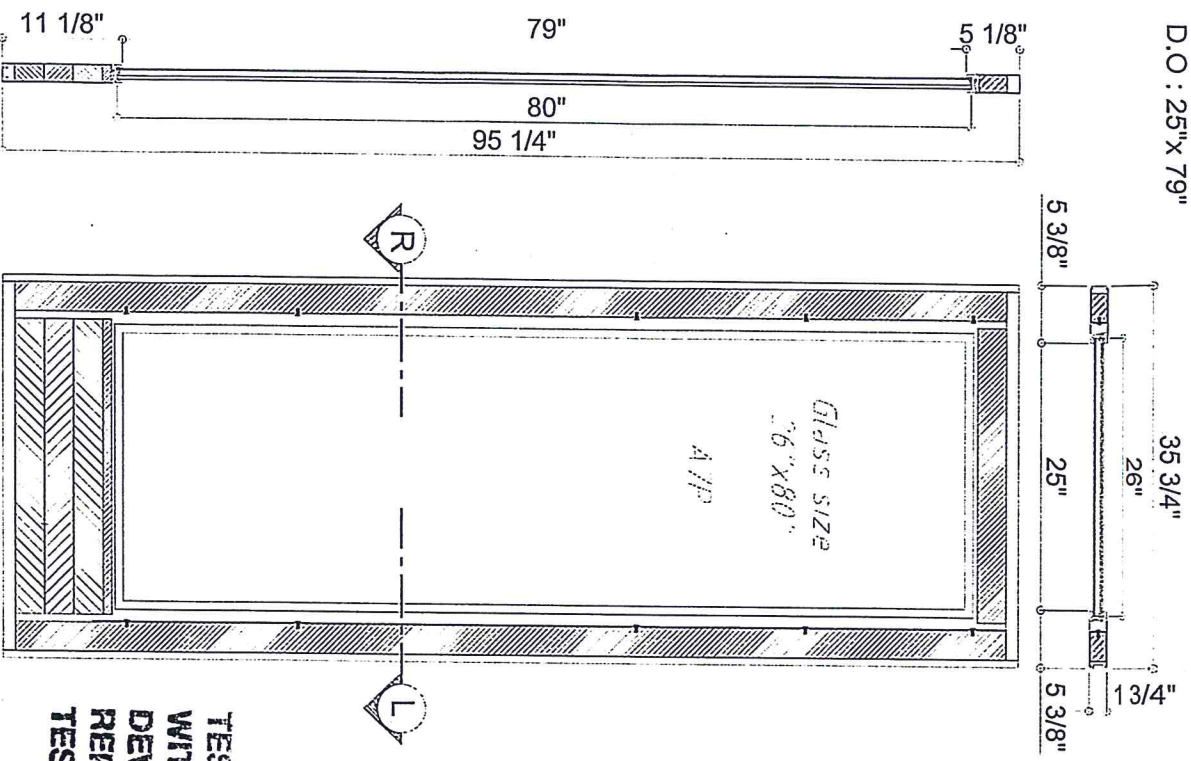

TEST SPECIMEN COMPLIES WITH THESE DETAILS. ANY DEVIATION IS NOTED. REPORT NO. NCTL - 210 - 4112-04 TEST DATE: 07/20/18

REVISIONS	DATE	DRAWN BY	DWG NO.	SHEET	SHEET TITLE:
	Aug/02/2018	Ruskin Wu		7 of 12	8'0" Height Outswing Patio Door OXXO Active Panel Door
<p>NAN YA PLASTICS CORPORATION OFL201, Tung Hwa N. Road Taipei, Taiwan Tel: (886)2-2715-2211 ; Fax: (886)2-2717-6512</p>					

8'0" A7P Outswing Passive Panel Details

Door Slab Size: 35 3/4" X 95 1/4"

Glass : 26" X 80"

D.O : 25" X 79"

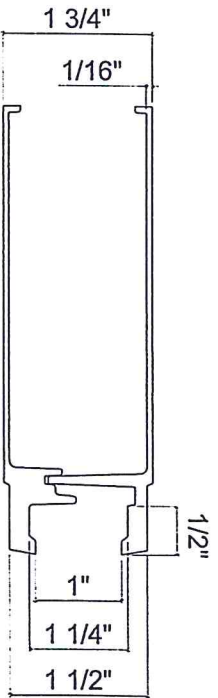
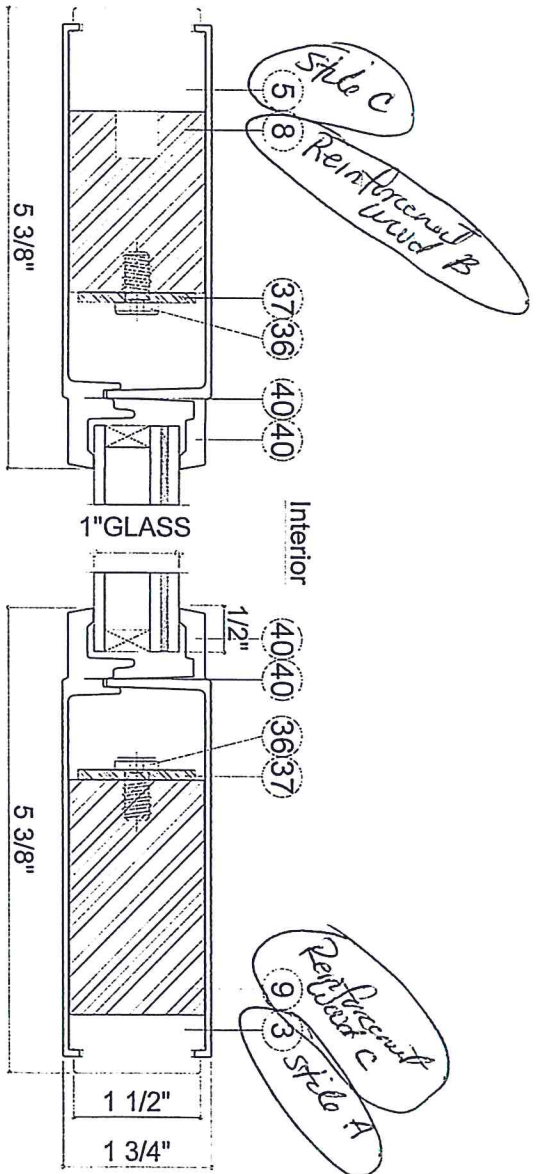
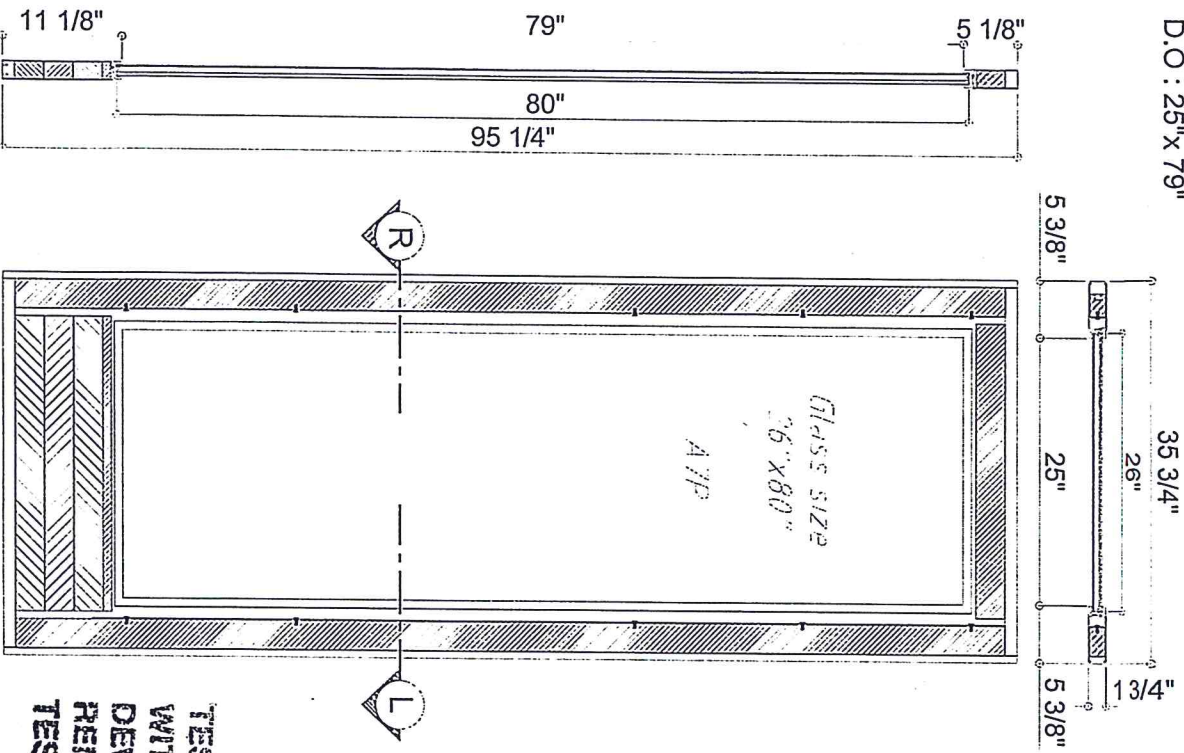

TEST SPECIMEN COMPLIES WITH THESE DETAILS. ANY DEVIATION IS NOTED. REPORT NO. NCTL - 210 - 4112-04 TEST DATE: 07/20/18

REVISIONS	DATE: Aug/02/2018	SHEET: 8 of 12	SHEET TITLE: 8'0" Height Outswing Patio Door OXXO Passive Panel Door
	DRAWN BY: Ruskin Wu		
	DWG NO.:		



NAN YA PLASTICS CORPORATION
 6F, 201, Tung Hwa N. Road Taipei, Taiwan
 Tel: (886)2-2712-2211 : Fax: (886)2-2717-6512

8'0" AZP Outswing Stationary Panel Details

Door Slab Size: 35 3/4" X 95 1/4"

Glass : 26" X 80"

D.O : 25" X 79"

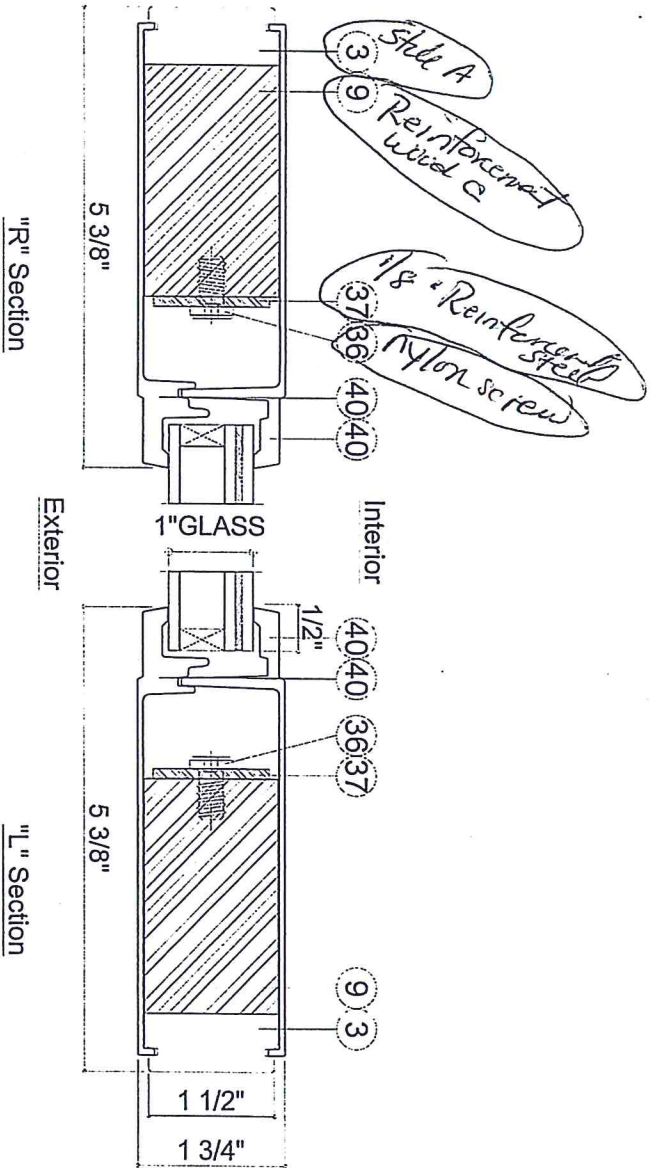
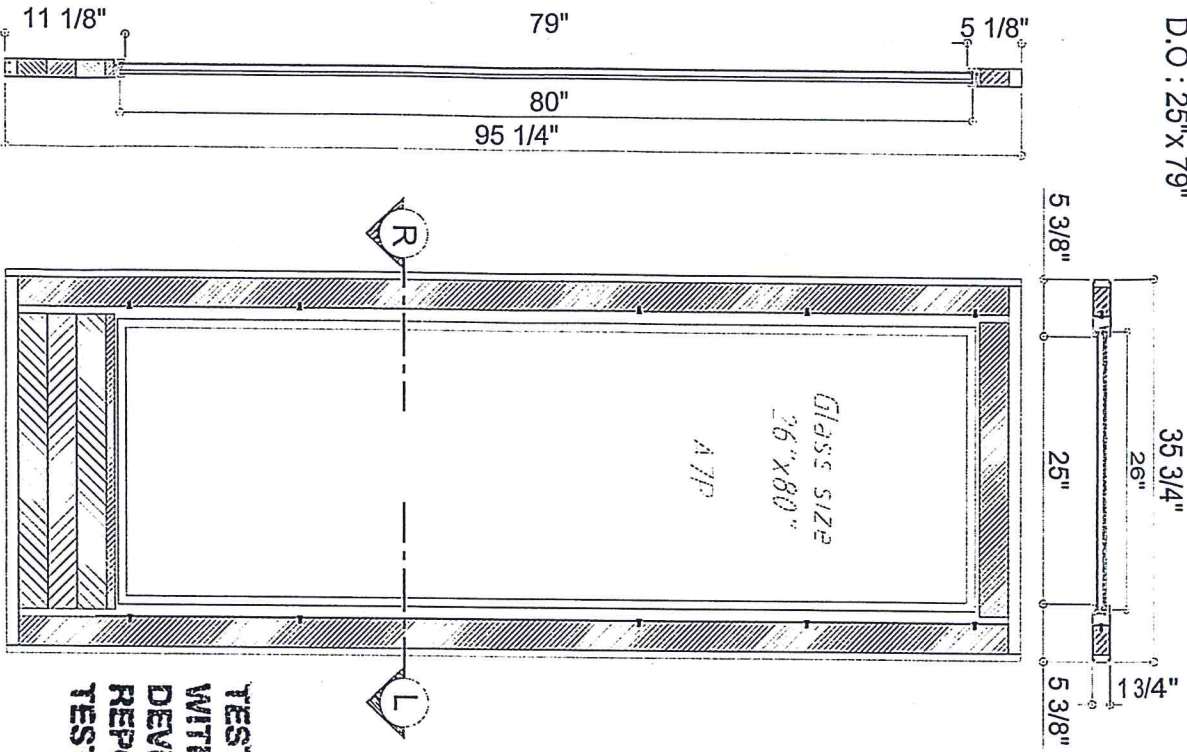

TEST SPECIMEN COMPLIES WITH THESE DETAILS. ANY DEVIATION IS NOTED. REPORT NO. NCTI - 210 - 4112-04

TEST DATE: 07/20/18

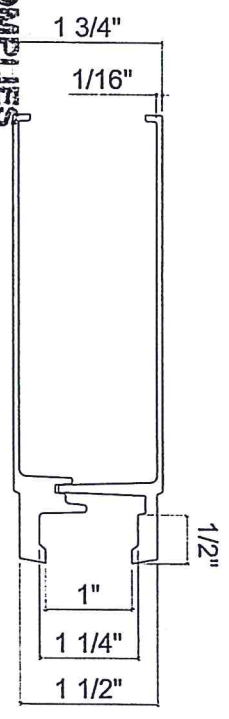

REVISIONS	DATE	DRAWN BY	DWG NO.
	Aug/02/2018	Ruskin Wu	
SHEET TITLE: 8'0" Height Outswing Patio Door OXXX			
Stationary Panel Door			
NAN YA PLASTICS CORPORATION 6FL, 201, Tung Hwa N. Road Taipei, Taiwan Tel: (886)2-2712-2211 ; Fax: (886)2-2717-8812			

(14) ASTRAGAL(A) FOR PASSIVE PANEL IN INTERIOR

93.21/32"

TEST SPECIMEN COMPLIES WITH THESE DETAILS. ANY DEVIATION IS NOTED.
REPORT NO. NCTI - 210 - 4112 - 01
TEST DATE: 07/20/18

BOTTOM

(14) ASTRAGAL(A) FOR ACTIVE PANEL IN EXTERIOR

94.11/16"

BOTTOM

(15) REINFORCEMENT(A) FOR PASSIVE PANEL IN INTERIOR

93.5/8"

SCREW HOLE-7

BOTTOM

(15) REINFORCEMENT(A) FOR ACTIVE PANEL IN EXTERIOR

94.21/32"

SCREW HOLE-7

BOTTOM

(16) MULLION COVER(B)

94.5/16"

BOTTOM

(17) REINFORCEMENT(B)

94.5/16"

SCREW HOLE-7

BOTTOM

DATE	AUG/02/2018	SHEET	10 of 12	SHEET TITLE:	8'0" Height Outswing Patio Door OXXO Astragal Specification
DRAWN BY	Ruskin Wu				
DWG NO.					
REVISIONS					



NAN YA PLASTICS CORPORATION
0F-4201, Tung Hwa N. Road Taipei, Taiwan
Tel:(886)2-2712-2211 Fax:(886)2-2717-8512

Interior

Exterior

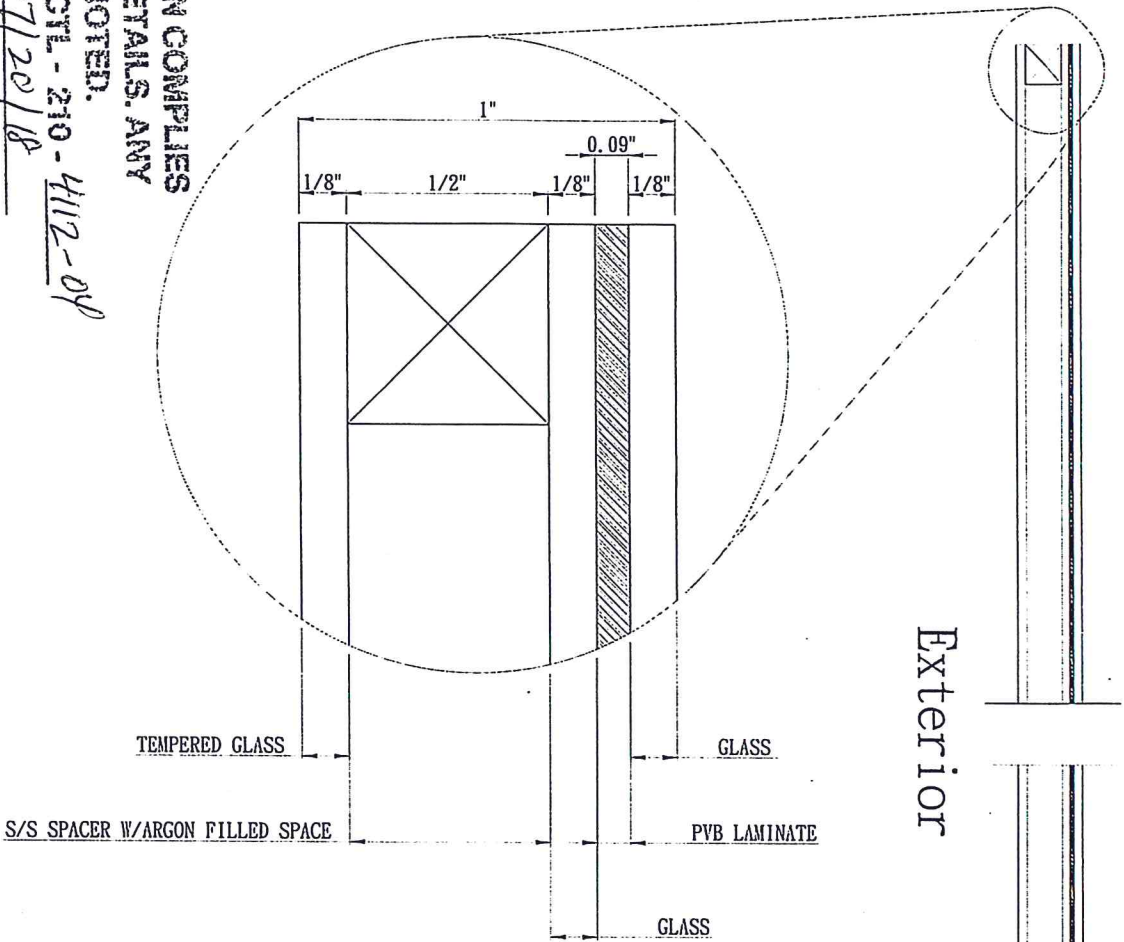

TEST SPECIMEN COMPLIES
 WITH THESE DETAILS. ANY
 DEVIATION IS NOTED.
 REPORT NO. NCTL - 210 - 4112-09
 TEST DATE: 07/20/18

DATE	Aug/02/2018	SHEET	11 of 12	SHEET TITLE:	1" Laminated Glass Consisting
DRAWN BY	Ruskin Wu				
DWG NO.	-				
REVISIONS					



NAN YA PLASTICS CORPORATION
 6FL, 201, Tung Hwa N. Road Taipei, Taiwan
 Tel: (886)227122211 ; Fax: (886)2271-8512

ANCHORING FOR 8'0" OUTSWING FOUR PANEL DOOR (OXXX) TO THE WOOD BUCK

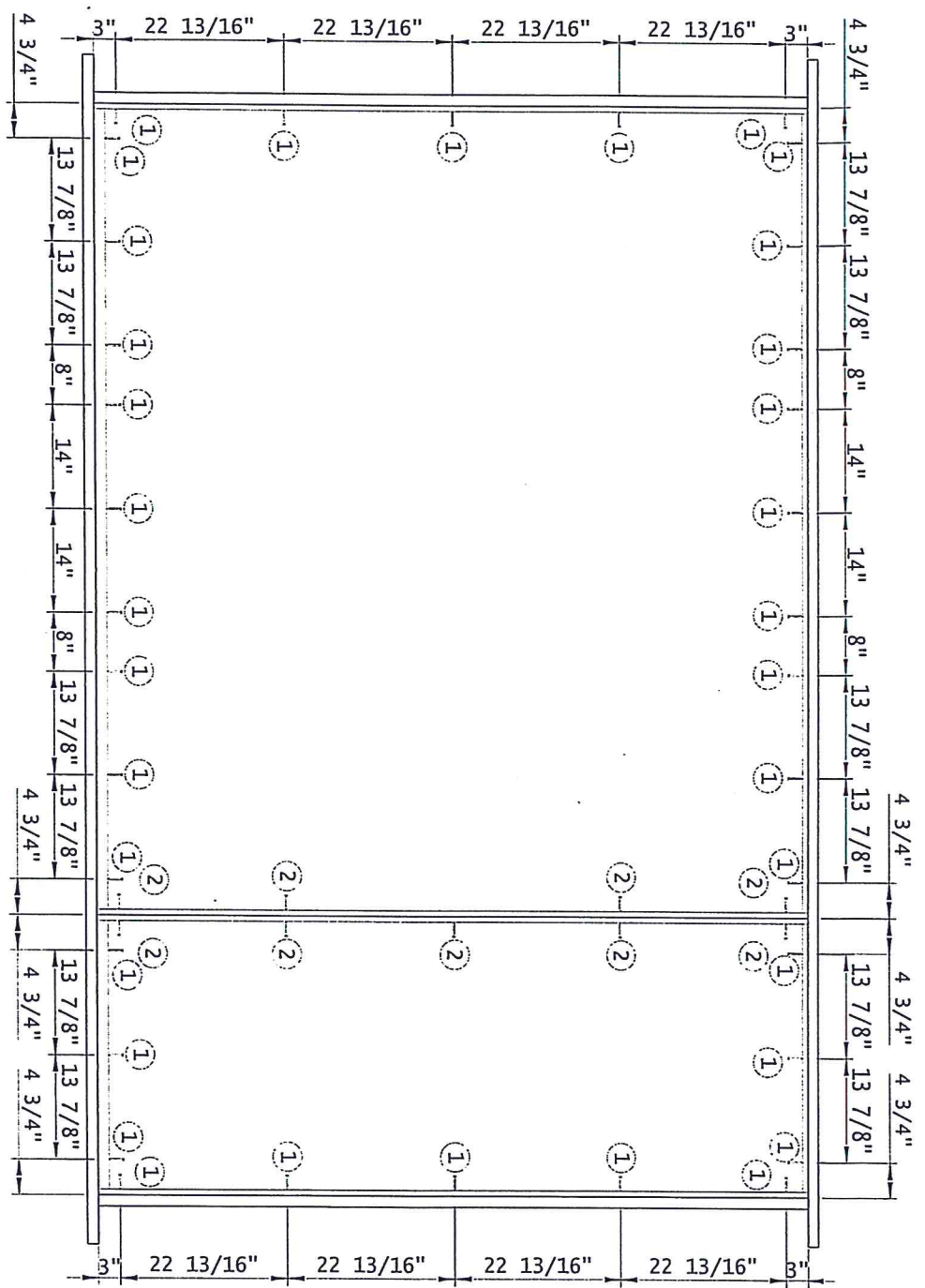

SCREW SCHEDULE

ITEM	MATERIALS	QTY
(1)	#10 X 3" PHILLIPS SQUARE DRIVE SCREWS	34
(2)	#10 X 2" PHILLIPS SQUARE DRIVE SCREWS	9

SEE DRAWING FOR DETAILS WITH THESE DETAILS, ANY OPERATION IS NOTED.
 REPORT NO. NCTL - 210 - 4112-04
 TEST DATE: 07/20/18

DATE	Aug/02/2018	SHEET	12 of 12	SHEET TITLE:	8'0" Outswing Four Panel Door (OXXX) To Wood Buck Screw Schedule
DRAWN BY	Ruskin Wu				
DWG NO.					
REVISIONS					

 NAN YA PLASTICS CORPORATION
 Off. 201, Tung Hwa N. Road Taipei, Taiwan
 Tel: (886)2-2713-2211; Fax: (886)2-2717-8512